

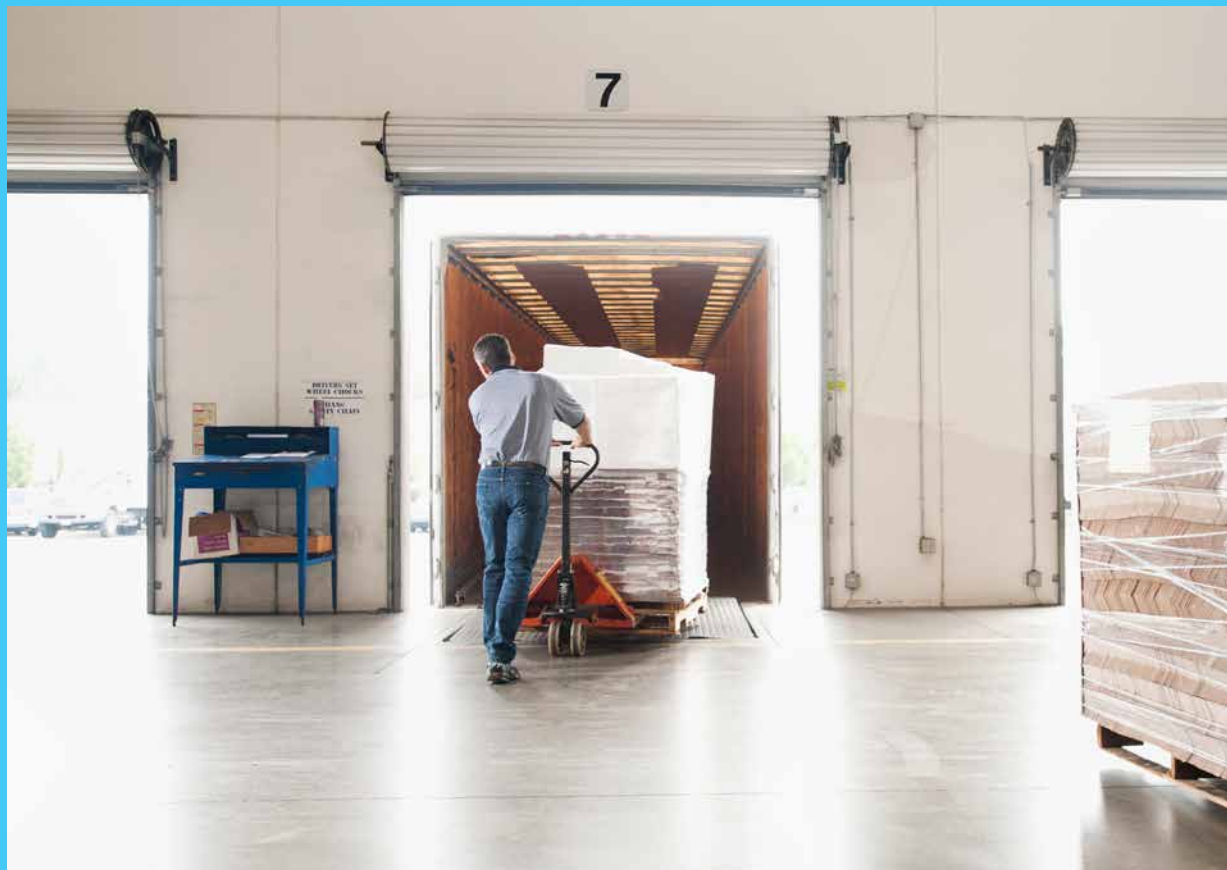

# Safe and Efficient Goods Reception for Road Freight



## Foreword



**Umberto de Pretto**  
Secretary General IRU

The IRU International Guidelines on Safe and Efficient Goods Reception for Road Freight were developed to respond to the gap in global guidance for professionals involved in transporting goods by road.

On behalf of IRU and all of its members across five continents, I would like to extend a special word of appreciation to IRU's International Commission on Technical Affairs (CIT) and to external experts for making the development of the guidelines possible.

The CIT's commitment and expertise have been central to this effort to establish a valuable tool to guarantee the safe reception of goods and safe working environments for all those involved in the loading, unloading, collection and delivery of goods during road transport operations.

Aimed at IRU's global membership and relevant stakeholders in the road transport industry, I would encourage all to follow these comprehensive recommendations as a reference to ensure that safety comes first.

**Mårten Johansson**  
**President IRU International Commission on Technical Affairs (CIT)**  
**Director of Technical Affairs and lead Auditor,**  
**Swedish Association of Road Transport Companies, Stockholm**



Safe and Efficient Goods Reception for Road Freight has been developed in collaboration with members of the IRU International Commission on Technical Affairs, The Health and Safety Authority Ireland and TYA. The guidelines promote safe and efficient deliveries and collections of road freight and also include examples of safe practice from throughout the road transport sector.

The IRU International Technical Commission (CIT) is confident that the guidelines will help reduce the number of people injured as a result of goods delivery and collection related incidents, and prevent unnecessary and avoidable disruption to essential economic services.

Thank you to all IRU CIT Members, and a special thank you to Deirdre Sinnott McFeat and Gareth Thornton (HSA), Maria Vigren (TYA) and Jacques Marmy (IRU), who all helped to make this project a reality for the international road transport sector.



## Contents

<b>Chapter 1</b>	<b>Introduction</b>	<b>1</b>
<b>Chapter 2</b>	<b>The Basic Principles</b>	<b>4</b>
	1. Safe and efficient goods reception	4
	2. Thinking ahead	4
	3. Common goods reception areas	5
<b>Chapter 3</b>	<b>Adapting goods reception to the environment</b>	<b>8</b>
	1. Depot / warehouse	8
	2. Industrial facility	11
	3. Superstore	13
	4. Preschool, school	15
	5. Industrial kitchen, hospital, hotel	17
	6. Shopping centre / shopping mall	18
	7. Medium-sized shop	20
	8. "Hole in the wall" - small shop, pub, restaurant, kiosk	22
<b>Chapter 4</b>	<b>Key design considerations for goods reception elements</b>	<b>26</b>
	1. Goods reception design	26
	2. How to choose the best goods reception arrangement	28
	3. Loading house	30
	4. Gates	31
	5. Gate dimensioning	33
	6. Loading dock	34
	7. Dock leveller	34
	8. Safe docking	36
	9. Ramp	36
	10. Dock seals	37
	11. Step bridges	38
	12. Securing a vehicle or load carrier	39
	13. Inspection and maintenance	40
	14. Handling equipment	40
	15. Traffic management	43
	16. Moving between different slopes	46
	17. Help reversing	47
	18. Fire safety and theft prevention	50
	19. Lighting	54
	20. Waste sorting and return of goods	56
	<b>References</b>	<b>58</b>



## Introduction

# Safe and efficient goods reception for road freight

Deliveries and collections are essential to business, but for those involved — including drivers, loading staff and general operatives — it can be a dangerous activity.

Every year thousands of workers suffer serious and fatal injuries when working around vehicles which are collecting or delivering goods.

Unless workplaces are suitably designed, and work activities are carefully controlled, people are at risk of:

- Being hit by moving vehicles (reversing vehicles in particular)
- Slips, trips and falls in the general work area
- Slips, trips and falls on or from vehicles
- Injuries caused by vehicles turning over (especially forklifts)
- Being hit by objects falling from vehicles
- Injuries from manual handling tasks

These guidelines will provide information, recommendations and good practices for different goods reception areas. By considering safety, environmental factors and cost effective measures, it will enable users to select the best solution based on their specific requirements.

By providing practical examples and supporting graphics depicting good practice arrangements, these guidelines will help to promote safe and efficient goods reception, ensuring a safe working environment for all those involved in the loading, unloading, collection and delivery of goods.

The guidelines will address the different aspects involved in the design, operation and maintenance of a goods reception area:

**a. The environment:** information and guidance is provided on how to achieve safe goods reception in specific working locations, including depots and warehouses, industrial facilities, superstores, schools, industrial areas, hotels, hospitals, shopping centres, medium size shops, private convenience stores, kiosks and restaurants. This section also considers the following questions in relation to each different environment:

- The different types of goods: do they require loading docks or mechanical or manual handling at ground level?
- The different vehicle combination types: are the sizes of the loading docks, gates and dock seals appropriate to vehicle types?
- Traffic management considerations: what is the level of traffic control? Are the traffic routes and rules clearly shown on site maps and information boards?

**b. The stakeholders:** depending on the tasks and operations, who has the responsibility to ensure safety (business owner, consignor, consignee, driver, loading or unloading staff, warehouse operative, shop staff, supervisory staff, architect)?

**c. Facility design considerations:** information and guidance is provided about specific design considerations such as the loading dock, height difference, dock levellers, gates, mechanical and manual handling equipment, traffic control, fire safety, theft prevention, lighting and vehicle compatibility.

The guidelines are also meant to help architects and warehouse companies make the right decisions when building, renovating and upgrading goods reception areas.

Many people are injured every year while collecting or delivering goods.

Accidents or incidents could be prevented if all stakeholders (consignors, carriers, consignees) cooperate and coordinate their work.

These guidelines will include recommendations on the following key issues:

- Road transport companies should inform, instruct and train drivers on safety precautions when visiting places of work, particularly regarding the risks involved in loading and unloading delivery vehicles;
- All stakeholders in the freight chain should provide transport companies with information relating to loading/unloading operations; especially when additional handling equipment is required at the reception site;
- Road transport companies should be informed of traffic planning rules at site of collecting/delivering goods;
- Before entering the site, drivers should make sure that the vehicle and required equipment is damage free, safe and suitable for loading/unloading.





## Chapter 2

# The Basic Principles

## 1. Safe and efficient goods reception

There is a need for extensive construction and renovation of goods reception areas to prevent accidents and increase efficiency. It has also become more common for premises to be used by multiple businesses. The design of goods reception areas affects the safety of all those involved in the delivery chain, and these guidelines will help promote a safer and more efficient working environment in such areas.

There are two main aspects of safety that should be considered in relation to goods reception:

- traffic safety: the way in which a vehicle approaches and departs a goods reception, which can affect members of the public such as customers, those living in the vicinity and children;
- workplace safety: the way in which the vehicle docks at the goods reception, which can affect the safety of workers such as commercial drivers and warehouse staff.

It is also important to remember that the design of goods reception areas may affect evacuation options, risk of fire, risk of theft, etc. The function of dock seals and air lock devices will

also affect the working environment for those working in the goods reception area.

These guidelines are aimed at stakeholders in many different industries and professions. They seek to influence how goods reception is planned, designed and used. The recommendations in these guidelines are based on proven experiences and good practice examples.

## 2. Thinking ahead

Those involved in the carriage of any kind of goods should take appropriate steps to reduce the risk of injury, damage to goods and damage to vehicles. This should be done according to the nature and the extent of foreseeable dangers. Stakeholders should comply with the industry standards and guidance in their respective fields, as well as national or international regulations.

When different employers are operating on the same goods reception sites, the work environment needs to be co-ordinated.

National regulations and rules on responsibility for co-ordination might apply in these cases.

Employers have a duty to provide a safe place of work, safe systems of work and safe work equipment. Additionally, under occupational safety laws in many countries, employers are required to provide instruction, information and training to enable employees to work safely without risk of injury.

Employees also have duties in relation to their working environment and their behaviour while at work. They are required to cooperate with their employer and should discuss safety issues with their employer.

Employers have duties to consult with employees on the working environment and safety considerations for all aspects of their work.

### 3. Common goods reception areas

The design of goods reception sites will vary depending on the type of vehicle combination in use.

#### 3.1. HGV goods reception area at stores

A typical goods reception area is designed to facilitate loading and unloading, delivery and collection of goods. The planning of how the goods reception area is accessed affects safety, the working environment and work operations. Factors that affect people in the vicinity of the goods reception area will be addressed here.

#### Constituent parts of a goods reception.

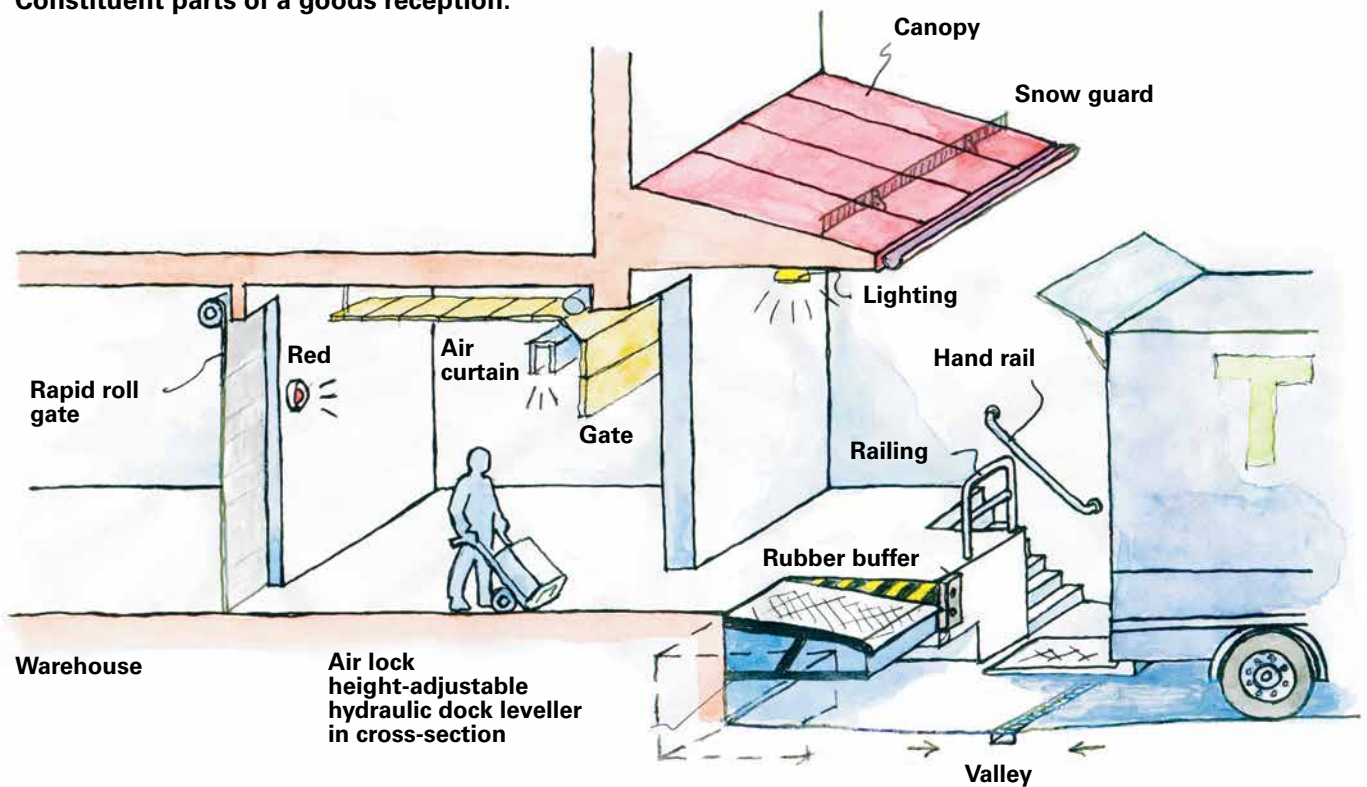

For loading and unloading work to be carried out effectively, efficiently and safely, additional equipment may be required to ensure good ergonomic handling practices are followed. That is why loading receptions situated outside the building, comprising a gate, a dock seal and a dock leveller, are common. The loading dock and goods reception, with associated equipment, shape a docking system.

**Goods reception with loading house.**

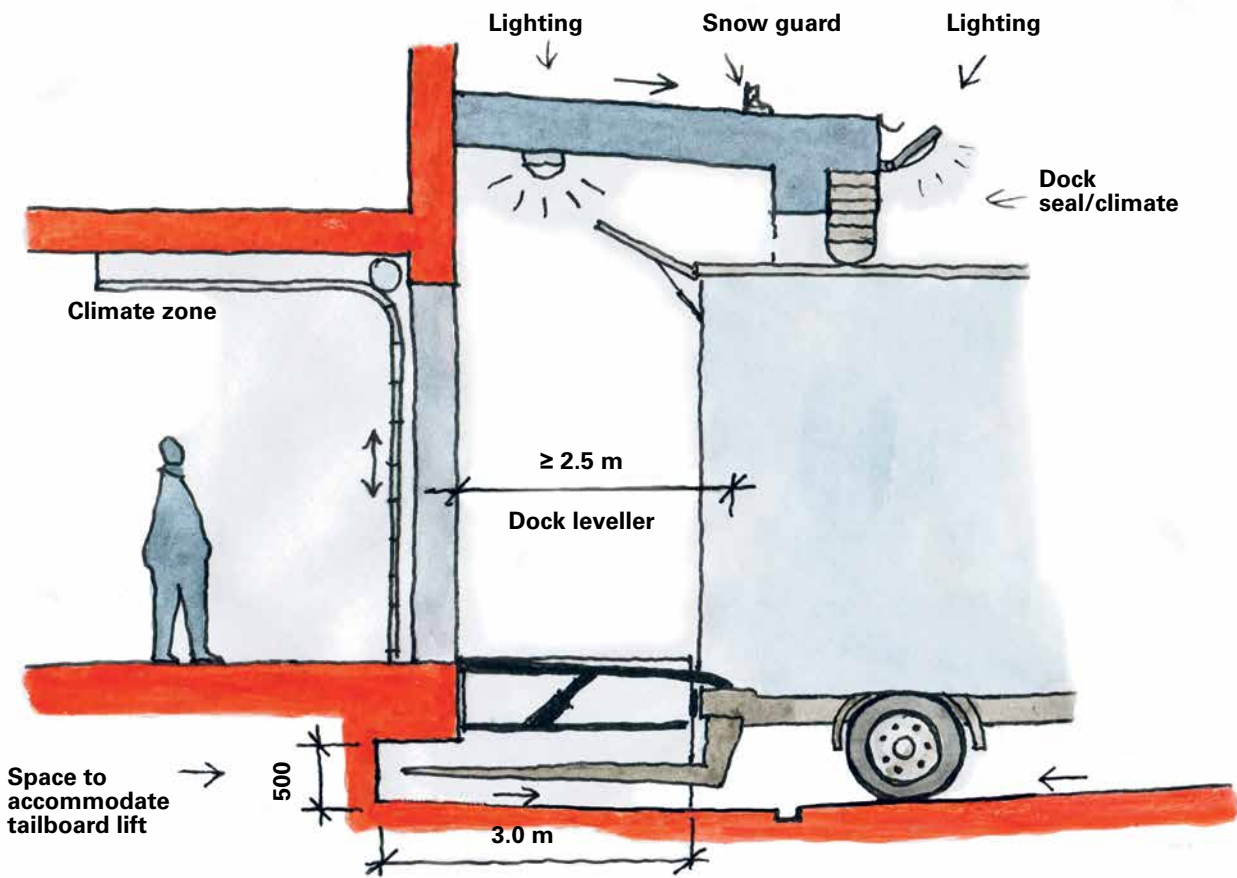

Slope towards valley gutter for water run-off so that the vehicle and load do not move.

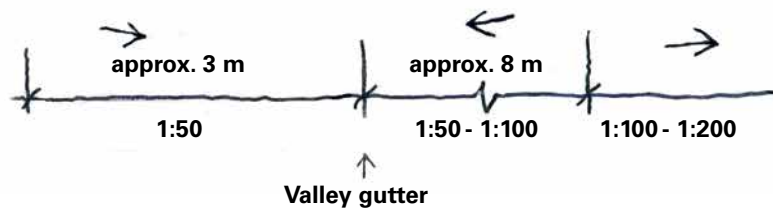

An older goods reception area may be supplemented with a docking platform and removable railing. If it is structurally possible, a canopy can be added above the docking platform.

**Modified older goods reception with added docking platform. Please note that a non-skid material should be applied to the docking platform.**

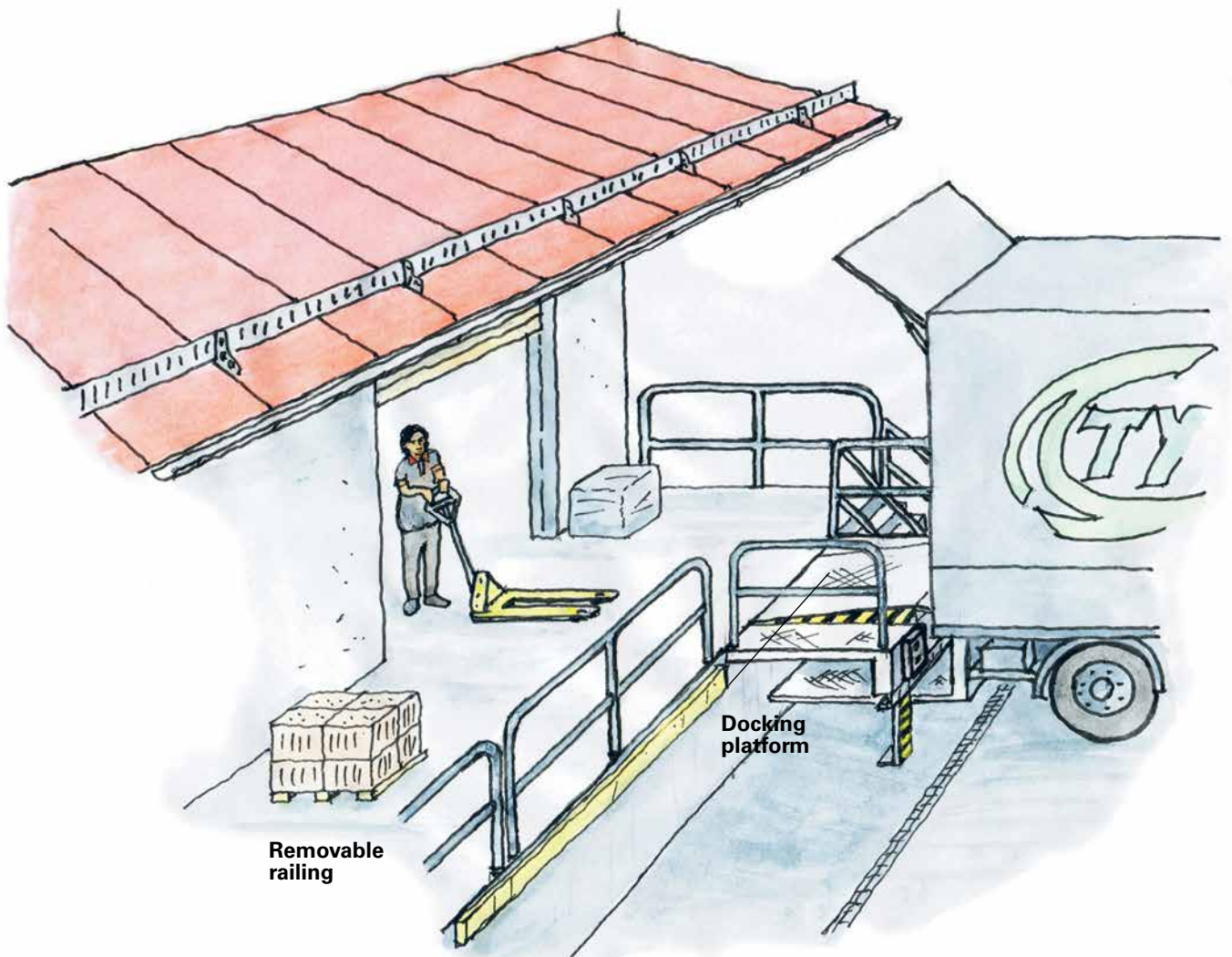

## Chapter 3

# Adapting goods reception to the environment

## 1. Depot/warehouse

There are often several different vehicle types operating at a depot or warehouse at any time. This means traffic planning is essential and information has to be provided about which rules apply to vehicle movements. It should be possible to reverse the vehicle up to the loading dock without disrupting other traffic and to get transport units into position without getting in the way of other traffic and people.

The nature of the business determines how safe and efficient goods receptions at depots and warehouses should be designed. Ideally, it should be possible to load and unload vehicles of varying sizes, including HGVs which need to 'dock' into the loading bay. The goods reception area should have loading docks with different heights and different seals to accommodate different HGV types and smaller vans.

## 1.1 Example

In this example of a goods reception at a depot, all loading and unloading takes place inside or via a weathertight loading house that protects employees from adverse weather conditions (such as rain, ice, snow and wind) and reduces the risk of incidents or accidents. In the example, it is assumed that traffic in the depot's goods reception is one-way and clearly planned. The example also has several different areas for forklifts and other handling equipment. One advantage of this goods reception setup is that a vehicle loaded with long goods, heavy goods and general goods can be unloaded in one location in a logical order from both the loading dock and at ground level using forklift trucks. Close to the goods reception, there is a drivers' area with lunchroom, toilet and shower.

**Depot with undercover long-goods and heavy-goods handling.**

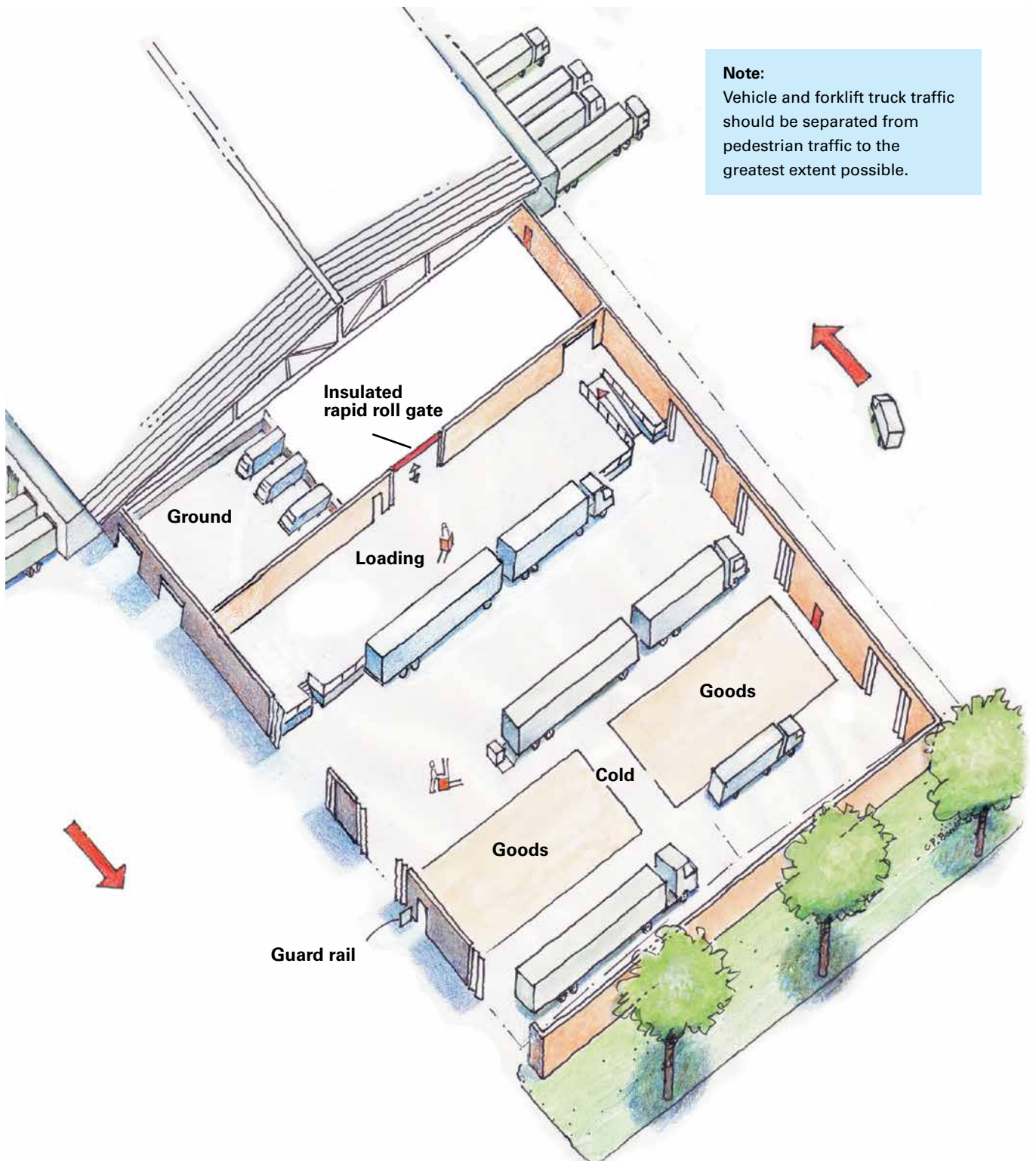

**Note:**  
Vehicle and forklift truck traffic should be separated from pedestrian traffic to the greatest extent possible.

**Weathertight goods reception with dock leveller for delivery vans.**

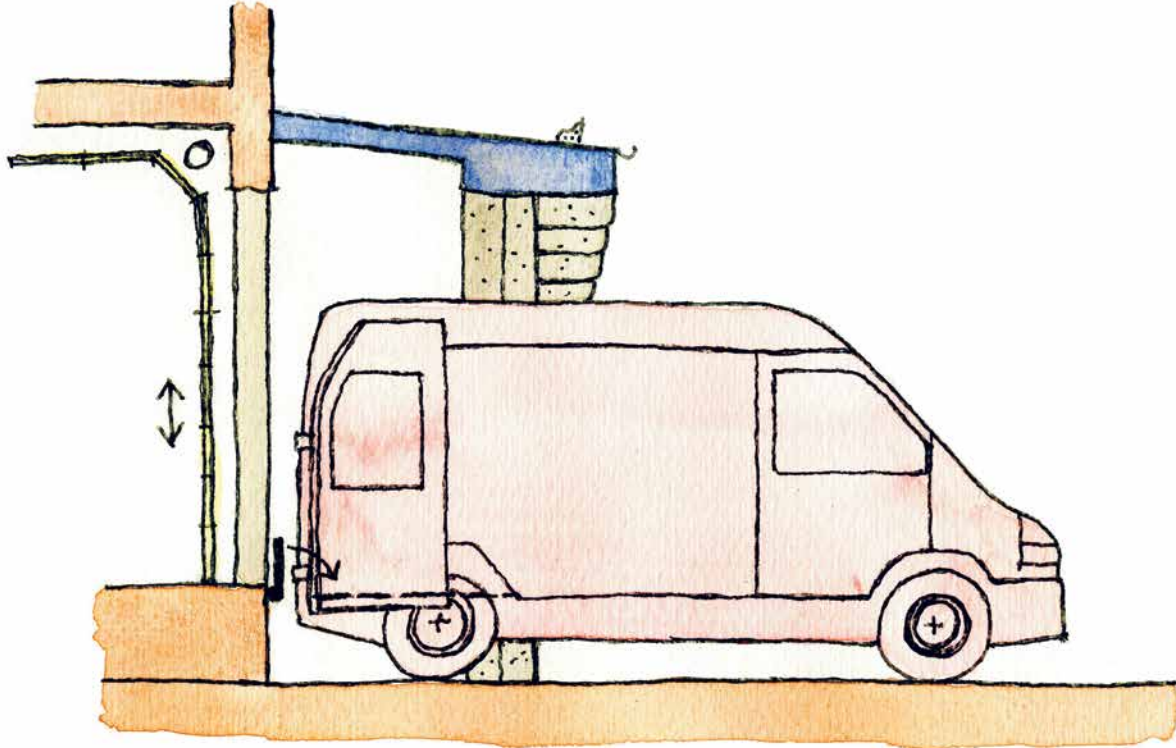

**Weathertight indoor loading and unloading of delivery van.**

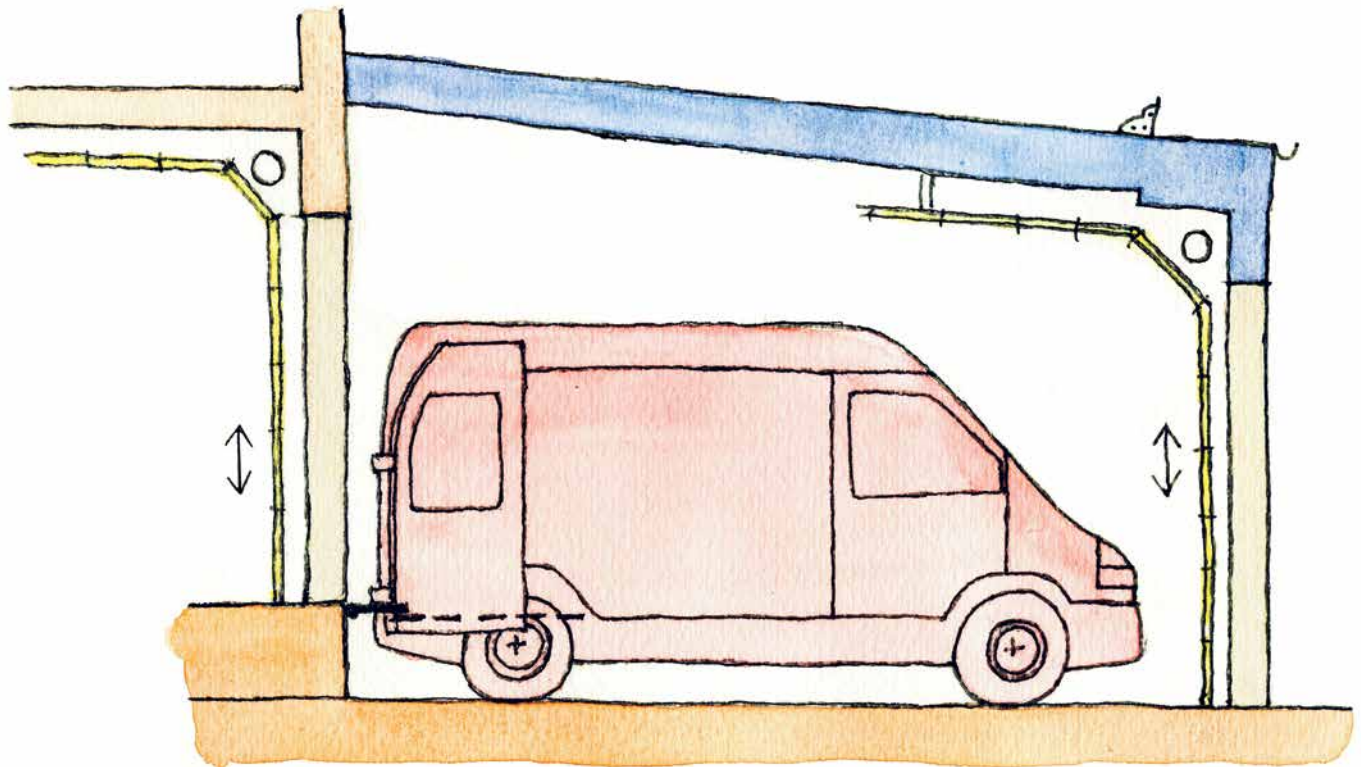



## 1.2 Things to consider

- Different types of goods handling requires loading docks and handling at ground level using forklift trucks.
- Different vehicle heights should be taken into consideration when planning gates, loading docks and dock seals.
- Different vehicle types require different sized loading docks, gates and dock seals.
- Traffic planning should be given particular consideration. The traffic rules at depots and warehouses should be shown clearly on site maps and information boards.

## 2. Industrial facility

At industrial facilities there is a need to handle different types of goods that are both long and heavy. There may be several different types of vehicle, including service vehicles. In addition to the work involving loading and unloading, there may be frequent entering and exiting with goods while production is underway in the goods area.

Loading and unloading takes place either from/onto a loading dock or at ground level.

Loading and unloading of general goods can take place from/onto loading docks with loading docks and docking systems.

Large goods are best unloaded under a cover at loading dock level. See illustration entitled 'Depot/warehouse' in Chapter 3.1.

Loading and unloading can also take place under a canopy at ground level using forklifts. Entry to warehouse or industrial premises takes place at ground level.

## 2.1 Example

In this example, access to and from the area is controlled using gates or barriers to prevent unauthorised traffic and pedestrians (workers and visitors). The traffic in the area is one-way. Combustible material is stored at a safe distance from the main building. Loading and unloading takes place under a canopy in a secure area.

To minimise draughts between the docking system and work premises, there is an air lock with a combination of rapid gates for entering and exiting with industrial trucks. Close to goods reception, there is a drivers' area with lunchroom, toilet and shower.

Another solution for industries with limited space might be to receive goods through loading docks positioned at a 45-degree angle. Such a solution both presupposes and facilitates a one-way traffic flow.

## 2.2 Things to consider

- If the facility is used by customers, it is important to make sure that different types of traffic do not mix, especially vehicles and pedestrians. Controls need to be effective to make sure vehicles do not interact unsafely, but instead operate in different areas.
- Appropriate gate solutions, for example air locks and day/night solutions.
- How to dimension gates for angled loading docks.
- Safe traffic when docking with loading docks.
- Combustible material should be stored a safe distance from the industrial premises.

### Loading and unloading undercover at ground level.

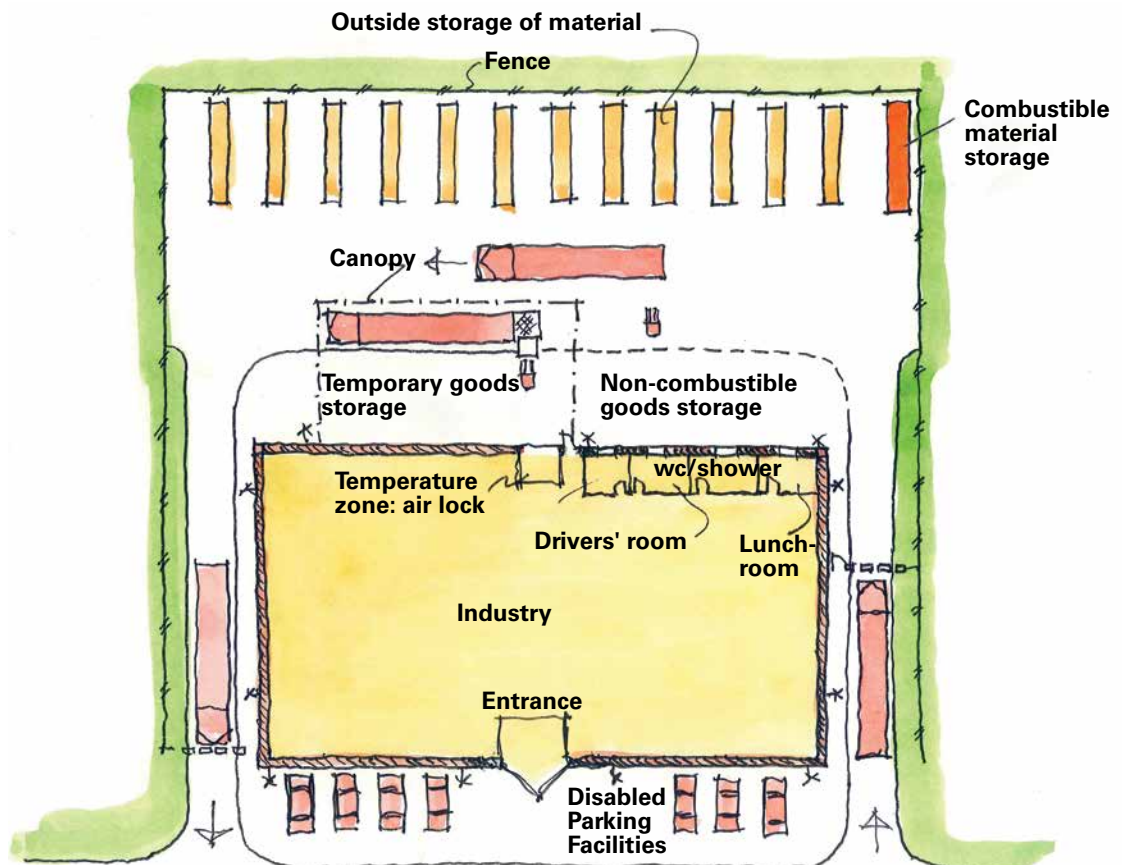

### 3. Superstore

The environment at a superstore is characterised by frequent deliveries of goods and high levels of customer traffic. Goods of a vastly varying nature are delivered to superstores – everything from building and garden products to food.

A safe and efficient goods reception area at a supermarket needs to be located so that no goods need to be loaded or unloaded around customers on their way into or out of the shop.

Handling requires there to be room for goods, return goods and other material, and for there to be access for transport units.

Driving areas should allow enough manoeuvring room for transport units with and without trailers. Loading docks at a superstore should be equipped with dock levellers and dock seals so that neither the driver nor consignees are exposed to weather elements. Chilled and frozen food should be handled in an unbroken cold chain. If it is not possible to have the entire goods reception area indoors or there is not enough space for a loading house/

docking system, there should be canopies to protect people from rain and reduce the risk of accidents.

Stairs should not be used for the manual handling of goods, or for pushing or carrying hand trucks or cages. The floor should have even surfaces and should be on the same level so that handling with rolling pallets, trolleys and wheeled cages can take place without jolts or lifting. It is also important to make sure floor surfaces are made of slip resistant materials to reduce risk, particularly when wet. Doors and fire doors should not have doorsteps. It should be possible to keep doors open to allow smooth passage of goods.

#### 3.1 Example

The loading docks have been positioned at a 45-degree angle towards the rear of the superstore due to limited space. This facilitates one-way traffic flow and reversing traffic. Customer traffic and goods traffic are separated effectively.

There are stations for loading and unloading several different truck types and an area for large goods handling.

#### Superstore with loading houses positioned at a 45°.

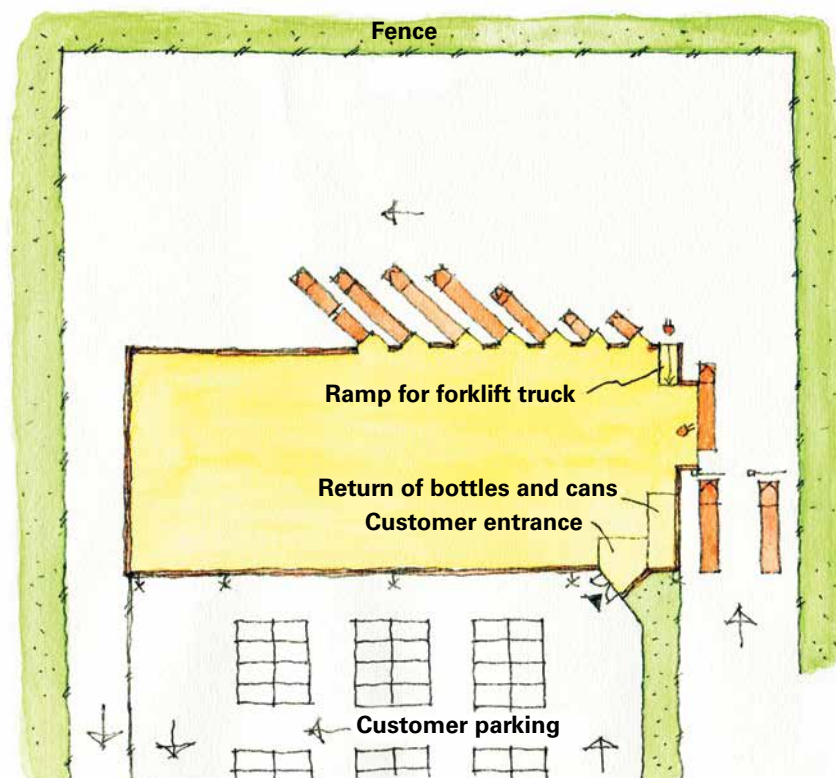

### 3.2 Things to consider

- Appropriate gate solutions, for example air locks and day/night solutions.
- How to dimension gates for angled loading docks. Safe traffic when docking with loading docks.
- Goods and part-loads that are to be taken away from the facility.
- Combustible material should be stored a safe distance from industrial premises.
- Different vehicle types require different sized loading docks, gates and dock seals.
- Risk of theft.

#### Detailed illustration of loading houses positioned at 45°.

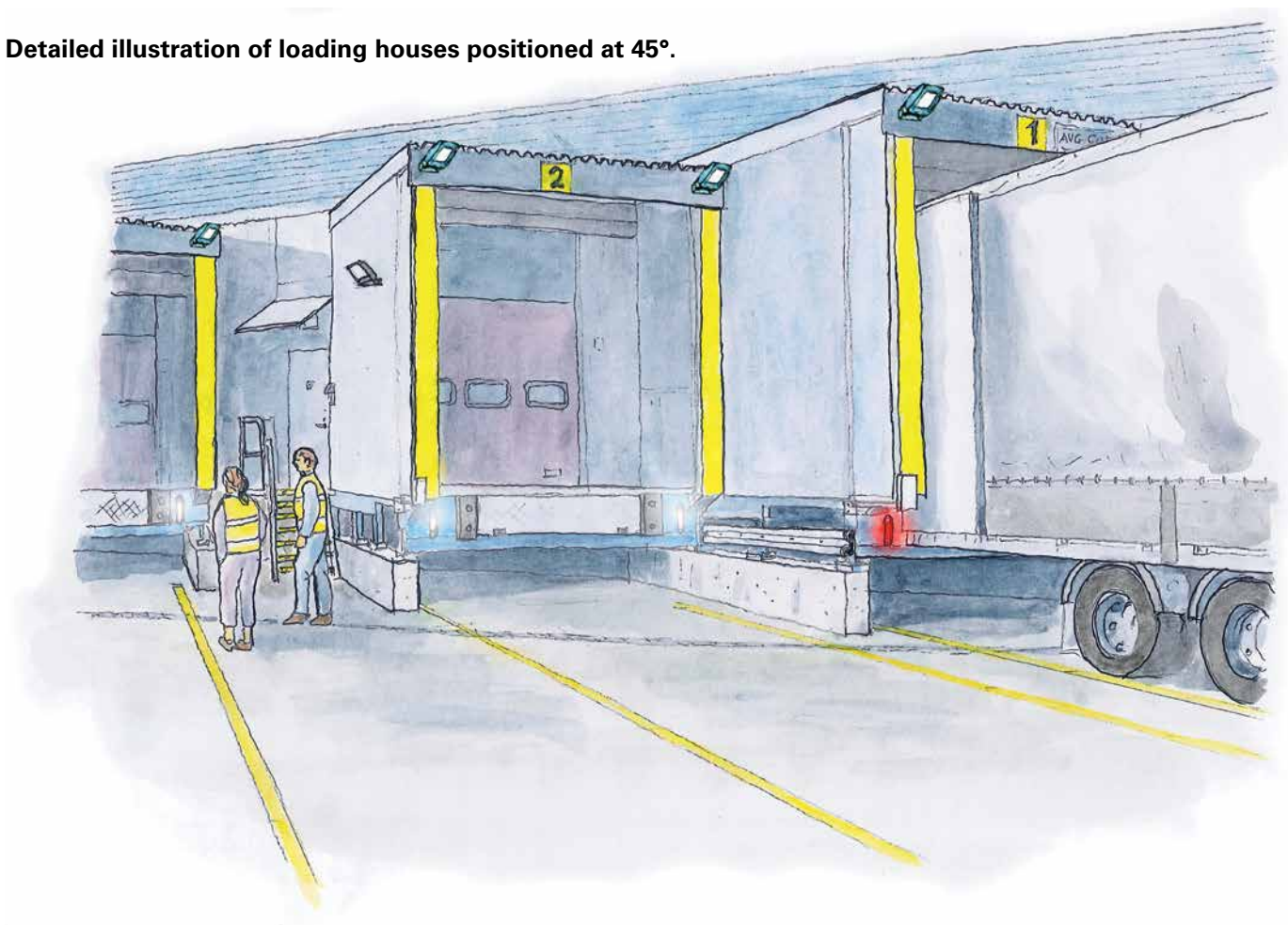

## 4. Preschool, school

Goods deliveries to preschools and schools involve an obvious risk of children being hit or run over by a large vehicle or sustaining injuries as goods are being unloaded.

Many preschools are arranged in a way that is good for learning, but this layout also means goods cannot be delivered without considerable difficulty. The same also applies to many schools.

Safe and efficient goods reception is arranged so that people (particularly children) and traffic are kept as separate as possible.

The most frequent operations involve food products, waste, fuels and school materials, but there may also be other types of delivery. If all deliveries can be made to the same place, this means there is as little traffic in the area for as short a time as possible. Kitchens should be located close to goods reception. Canteens and caretakers' offices should be located on the same floor as goods reception.

The driver should not have to reverse the vehicle in the vicinity of children or other people. That is why goods reception should be located in an external wall facing the road. If this is not possible, the access road should be planned so that the driver is only required to drive straight up to the goods reception area and then drive directly onto the street again after making the delivery. The access road to the goods reception should have a fence so that children cannot run out in front of the vehicle.

### 4.1 Example 1

In the example below, roads for commercial traffic and other traffic are separate. The children's way to school and playground is separate to the road for commercial transport. The need to reverse for distribution vehicles is eliminated or minimised. The goods reception area is located in the external wall and equipped with a canopy.

### Goods reception under canopy at preschool/school.

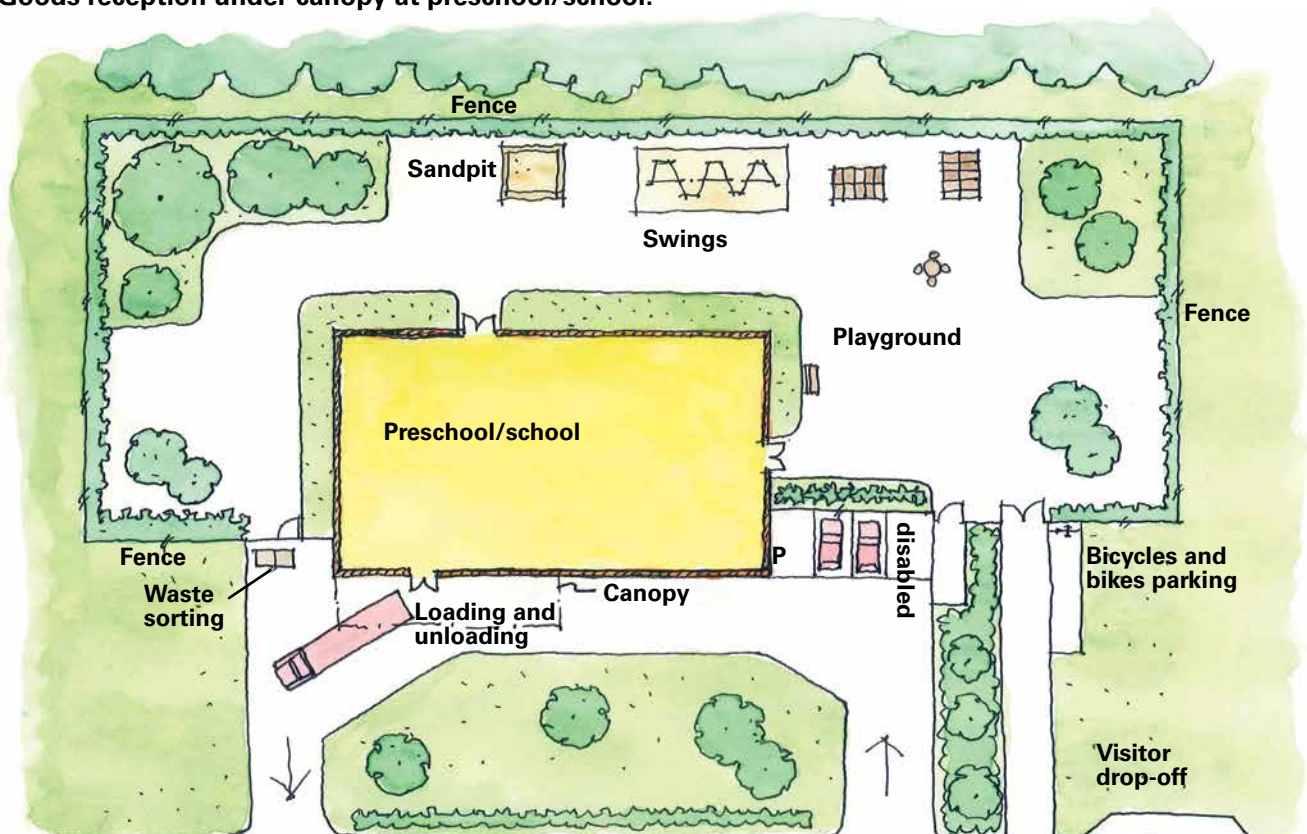

Goods reception should ideally be equipped with a loading dock or lifting platform. There should be a canopy that both protects people from rain and reduces the risk of slipping.

Stairs should not be used for manually carrying goods, or for pushing or carrying hand trucks or cages. If the storage area is not at street level, it should be possible to reach this using a lift big enough for the driver and lifting truck with pallet. Floors should be even and all on the same level so that rolling handling with pallets, trolleys and wheeled cages can take place without jolts or lifting. Doors and fire doors should not have doorsteps.

Goods, return goods and other materials should not be in the way of transport in corridors and access aisles; they should instead be stored in separate areas. It should be possible to keep doors open to allow passage.

#### 4.2 Example 2

The need to reverse is avoided in the example below. Commercial traffic and the children's way to school are separate. Parking for private cars is separate to that for commercial traffic.

There should be a fence at least 1,200 mm high around the area for commercial traffic. Bushes or hedges are not sufficient as a boundary.

#### 4.3 Things to consider

- Read more about the required loading dock height and height of gate or canopy over loading dock.
- Read about the dimensioning of driving surfaces for vehicles of different sizes.

#### Turning loop at preschool. Layout sketch. Goods reception separate from pedestrians (children/parents, etc).

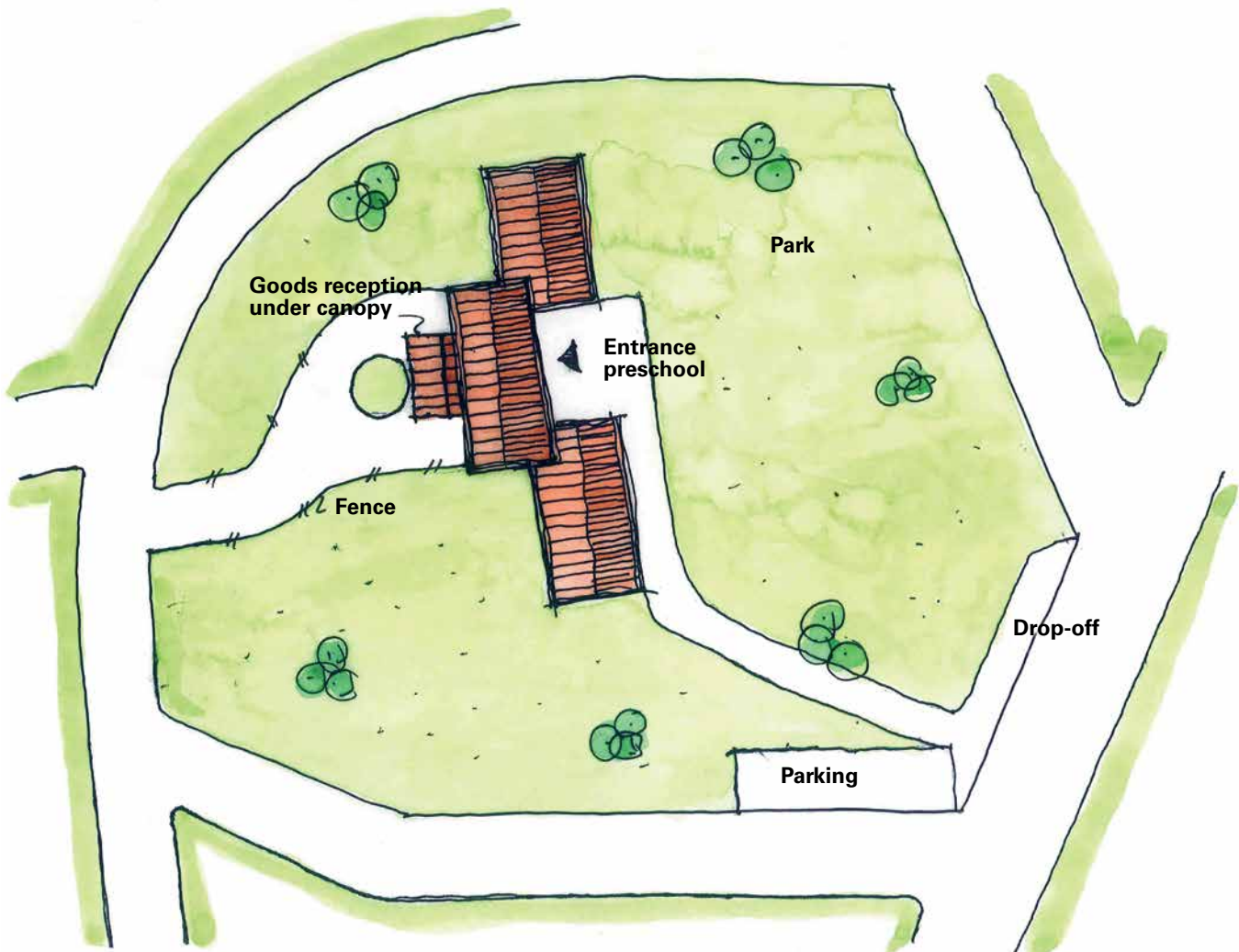

## 5. Industrial kitchen, hospital, hotel

Operations in industrial kitchens, hospitals and hotels may involve people-focused activities being carried out within the goods reception area. It means that at such establishments, large quantities of laundry and other materials that have to be handled separately are handled in addition to food products.

The way that safe and efficient goods reception at industrial kitchens, hospitals and hotels is set up varies according to the size and location of the establishment.

Driving areas and access roads should be designed for the vehicle type that tends to use them the most.

Bigger premises should have loading docks and be equipped to handle goods with pallets and wheeled cages to make sure those activities are safe.

There should be a canopy above the loading dock to protect people from rain and reduce the risk of slips, trips and falls on wet floors.

Floors should be even and all on the same level so that rolling handling with pallets, trolleys and wheeled cages can take place without jolts or lifting. Floor surfaces should be constructed with slip resistance materials to avoid slips, trips and falls. Doors and fire doors should not have doorsteps.

Goods, return goods and other material should not be in the way of transports in corridors and access aisles; they should instead be stored in separate areas. It should be possible to keep doors open to allow smooth passage of goods.

### 5.1 Example

This goods reception has different gates through which different types of commercial transports drive in and out. At each goods reception you will also find the containers and/or other areas, including both cold and normal refuse storage rooms, required for each goods type. The goods reception is set up so that loading and unloading take place under cover and there is a clear one-way traffic flow.

### 5.2 Things to consider

- Read more about the required loading dock height and height of gate or canopy over loading dock
- Read about the designing of driving surfaces for vehicles of different sizes
- Where deliveries are made on the street, rolling handling should be possible without stairs or level differences
- For bigger hotels and/or hospitals, it is important to be aware of the need for safe waiting areas for buses and taxis

### Goods reception set up.



## 6. Shopping centres and shopping malls

In shopping centres and shopping malls, there are many goods reception areas where a variety of activities are carried out. It means that such premises generate very large volumes of goods traffic. These should be streamlined to the greatest extent possible.

A model that has been proven to work well for shops, carriers and property owners alike is a shared, jointly staffed goods reception area.

When the driver arrives at one of these shopping centres, the goods reception employees can process the different shops' consignment notes while the driver unloads the goods. Handling cargo at goods reception is quick and very little time is spent at the loading dock. As a consequence, other vehicles arriving do not have to queue for a long time to use the loading dock.

### 6.1 Example 1

The example demonstrates a common goods reception at a shopping centre. Different vehicle types with different tasks can make use of aspects of the goods reception area without getting in each other's way. The example also shows a separate area for delivery vans.

There are containers in place for sorting different waste streams such as glass, cardboard and metal. Access to a designated container lift is provided to allow emptying of the refuse containers.

Containers are positioned so that they can be reached directly from the loading dock and employees do not have to walk among reversing vehicles.

Having a shared goods reception means the driver does not have to contact the consignor or consignee and wait for them to come to the loading dock to receive the goods.

Unless otherwise stated in the delivery conditions, the driver does not have to take the goods to the shop either and this lessens the risk of manual handling injury, theft and injury to visitors to the centre (risk of hitting someone with a pallet lift and similar equipment). The goods will either be temporarily stored at the shared goods reception and transported on into the shopping centre using internal transport or a shop employee will come to the shared goods reception to collect the goods when it is appropriate and safe for them to do so.

### Joint goods reception at a shopping centre.

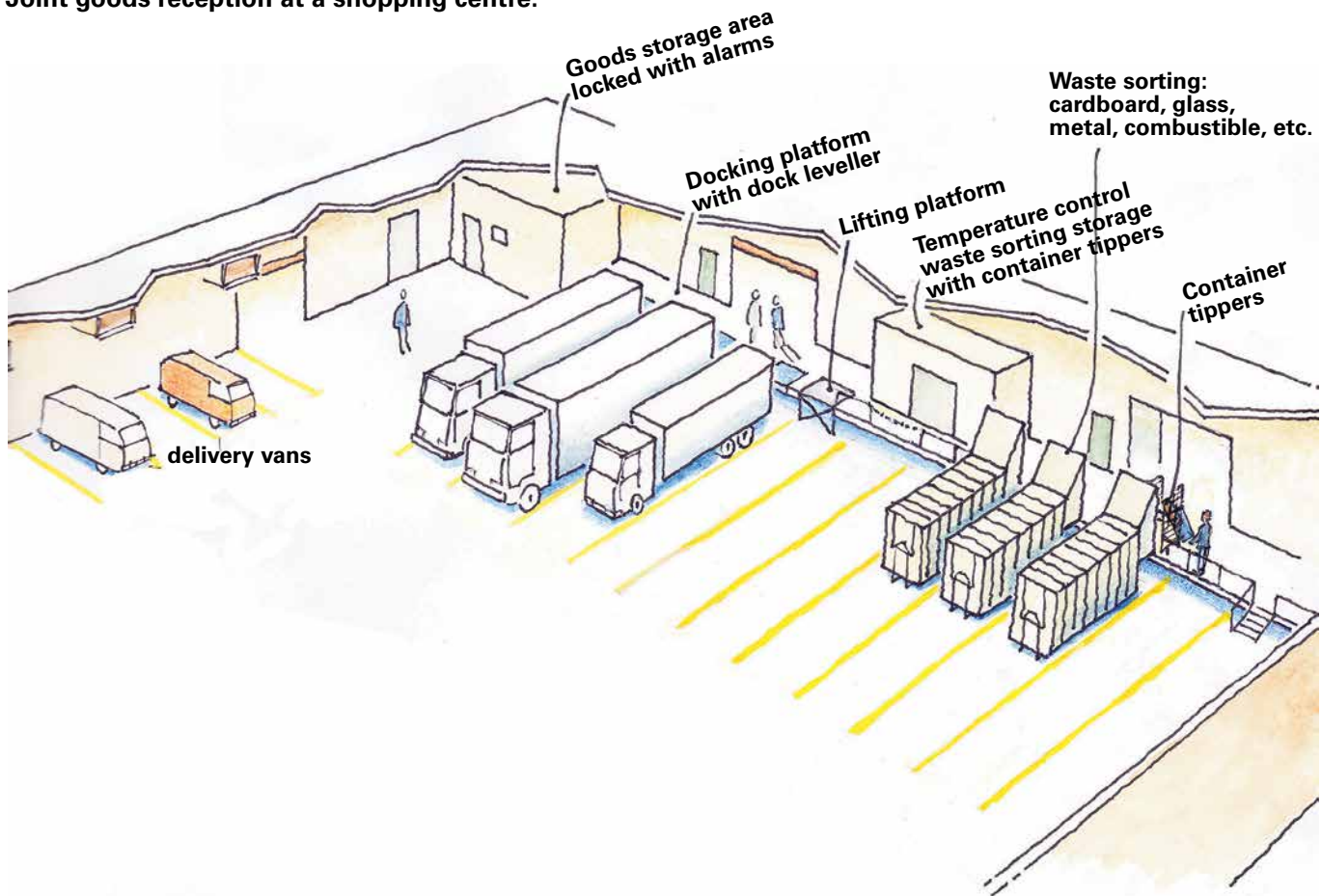



## 6.2 Example 2

This example is a view from the inside showing a loading dock at a common goods reception. The goods reception is staffed and internal transports for distribution to shops in the shopping centre or mall are co-ordinated.

## 6.3 Things to consider

- Risk of theft
- Goods and fractions that are to be taken away from the facility

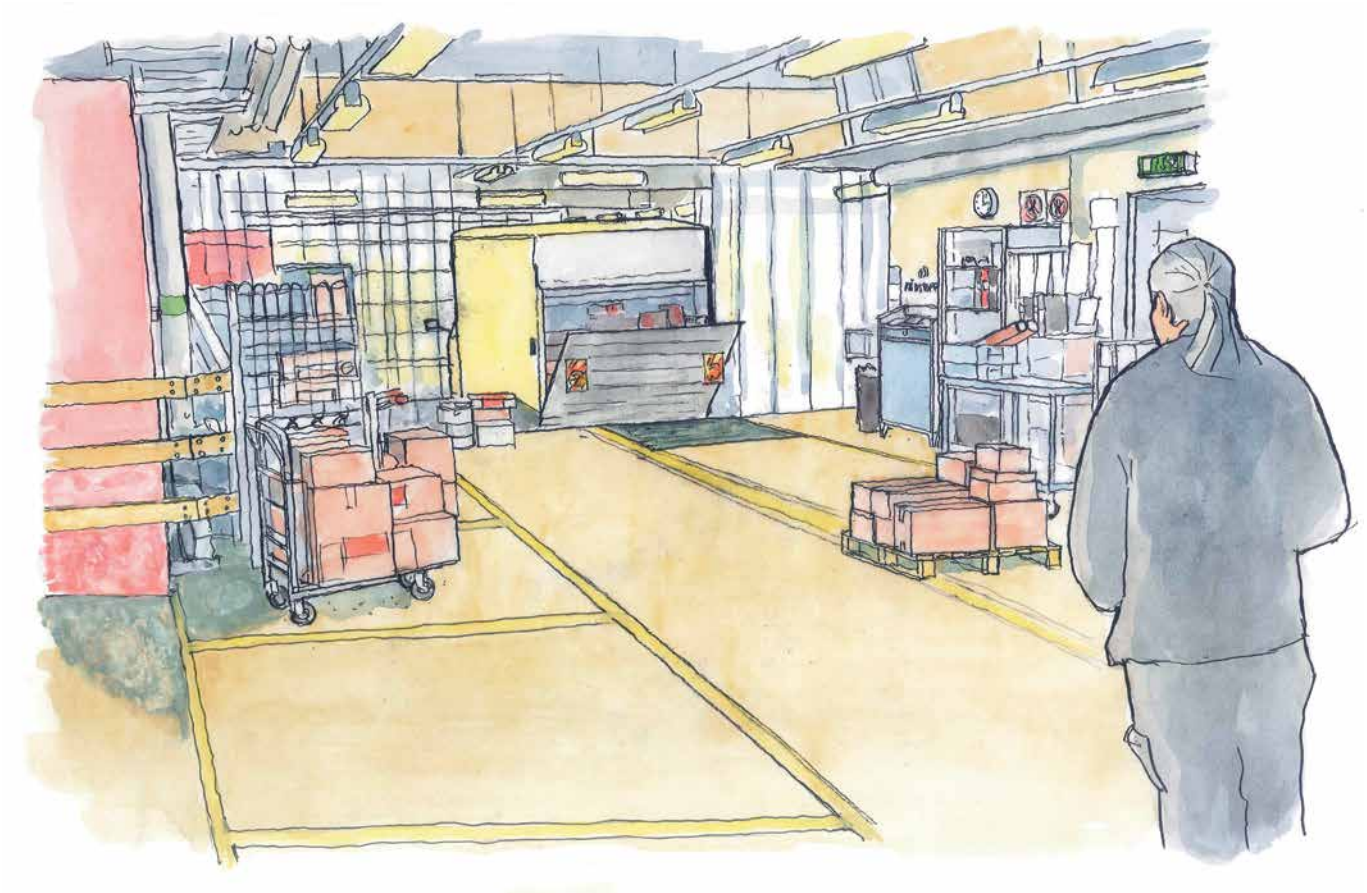

## 7. Medium-sized shop

There are many medium-sized shops in urban environments in particular – smaller department stores, specialist shops and food shops – that receive many goods deliveries from different suppliers on a daily basis.

These businesses generate a lot of return goods in the form of trolleys and pallets as well as large quantities of packaging to be taken away after sorting. These medium-sized shops are of course located where the customers are, which often means poor conditions for goods deliveries.

Whether the goods reception is common or for a particular shop, it should be equipped with a loading dock with weathertight loading house and dock leveller. The loading house should be designed so that different vehicle types can use the loading dock. There should be space for the vehicle's tailboard lift under the dock leveller. Alternatively, a flexible goods reception area can be set up with a loading house with dock seal and lifting platform instead of a dock leveller.

One important requirement is that a driver should be able to access the goods reception easily and safely, parking their vehicle legally without having to walk too far. The vehicle should have enough room to turn.

The floor should be even and level so that rolling handling with pallets, trolleys and wheeled cages can take place without jolts or lifting. Floor surfaces should be constructed with slip resistance materials to avoid slips, trips and falls. Doors and fire doors should not have doorsteps. If there are level differences, a lifting platform should be used.

Goods, return goods and other material should not be in the way of transports in corridors and access aisles; they should instead be stored in separate areas. It should be possible to keep doors open for smooth passage of goods.

### 7.1 Example

A flexible goods reception has the capacity to receive both bigger and smaller trucks, as well as smaller delivery vans. This is made possible by a height-adjustable lifting platform. A goods reception of this type will also have dock seals, meaning that the indoor climate is maintained when in use by both bigger and smaller trucks. When even smaller vehicles use the goods reception, it is advisable for the goods reception to have an air lock to eliminate draughts for the employees working in goods reception. It has two rapid roll gates.

#### Flexible goods reception. Layout sketch.

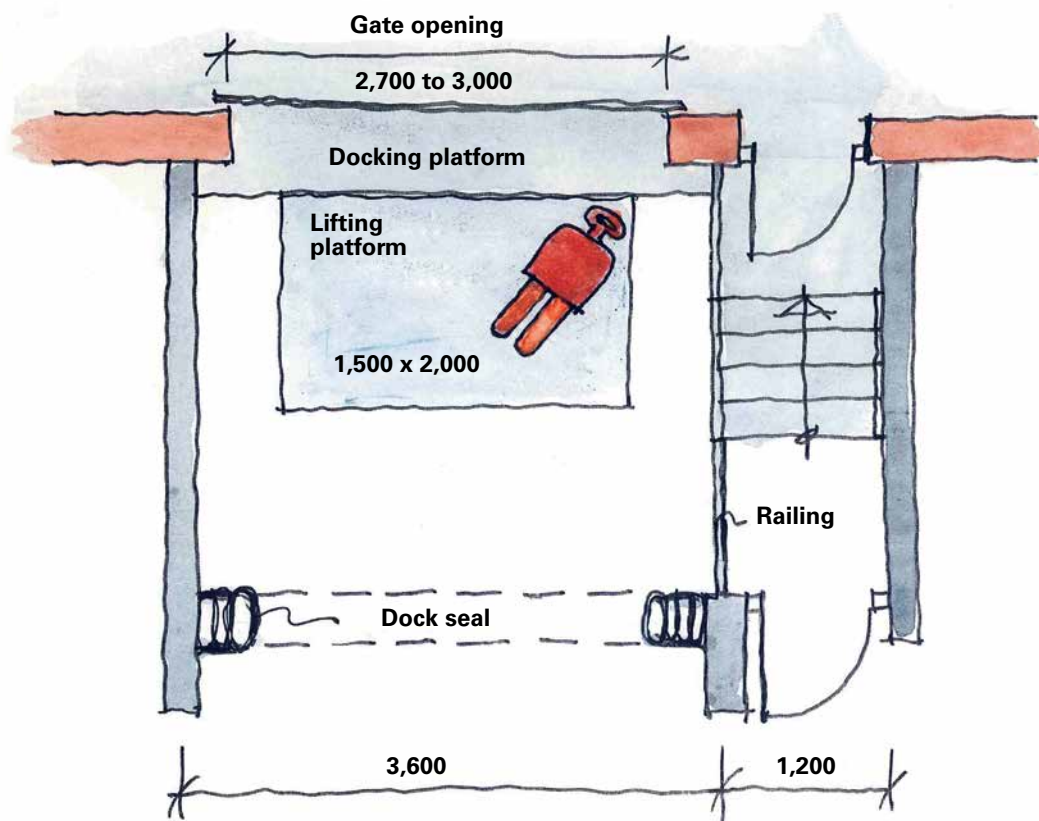

There are steps next to the loading dock. These are required both in the event of the premises being evacuated and to allow the driver to get up onto the loading dock without having to squeeze in behind the vehicle.

In very tight spaces, for example a courtyard where a goods reception area cannot be built, a solution with a loading dock lip on which the tailboard lift can be rested can be used.

**Flexible goods reception, cross-section.**

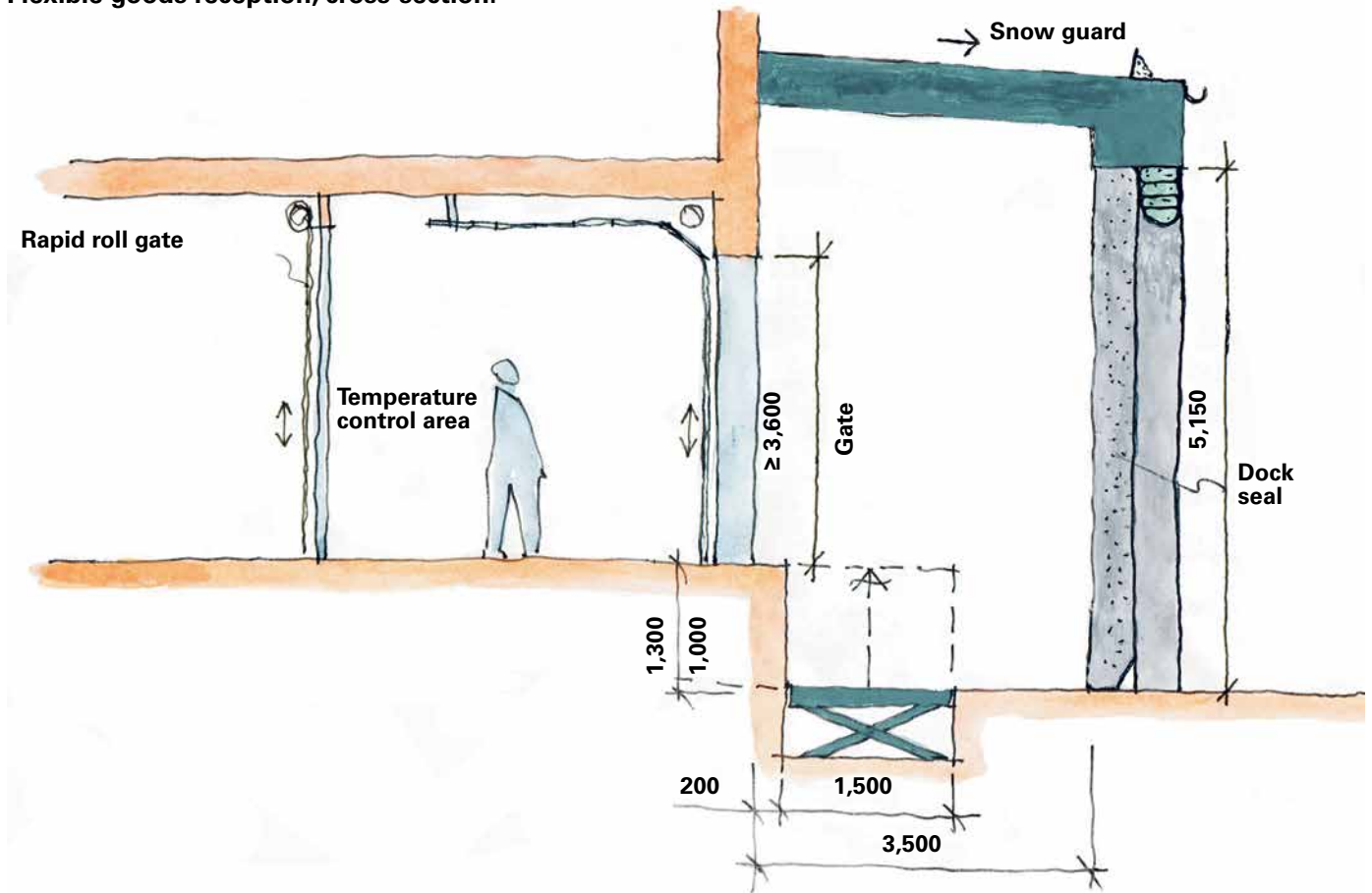

## 8. "Hole in the wall"- small shop, pub, restaurant, kiosk

Many goods deliveries in urban environments take place at smaller premises such as shops, restaurants or convenience stores. These deliveries often take place on busy streets with pedestrians and other types of traffic.

In these environments the conditions for safe goods handling are often limited. The way that safe and efficient goods reception is set up varies according to the size and location of the establishment and the local traffic conditions.

One important requirement is that a driver should be able to call at the goods reception easily and safely, thereby parking their vehicle legally without having to walk too far. The driver should be able to contact the shop employee using an accessible bell or similar device.

Where several premises use the same goods reception area, there should be a loading dock with lifting platform.

Where deliveries are made on the street, handling of goods, trolleys and pallets should be possible without stairs or level differences.

Vehicles should be able to park on hard level ground to allow for ease of pushing and pulling of pallets and cages of goods in particular.

The condition and arrangement of public roads, pathways and footpaths is often not under the direct control of the business owner. But if issues arise with the safety of roads and path surfaces that are necessary for access to business premises, the business owner should report concerns to the responsible body.

The floors outside and within premises should be even and all on the same level so that rolling handling with pallets, trolleys and wheeled cages can take place without jolts or lifting. Floor surfaces should be constructed with slip resistant materials to avoid slips, trips and falls. Doors and fire doors should not have doorsteps. If there are level differences, a lifting platform should be used.

Goods, return goods and other material should not be in the way of transports in corridors and transport routes, but should be stored in a separate area. It should be possible to keep doors open to allow smooth passage of goods.

### 8.1 Example 1

Access to the logistics zone should be possible without reversing the vehicle. The driver can lower the tailboard lift onto the raised unloading platform. It will then be easy for a hand truck or pallet lift to be brought to the vehicle either on the pavement or by crossing to the other side of the road.

Since the vehicle has to be horizontal, the logistics zone and its unloading platform should not be on a slope. These surfaces should be level. Heating coils can solve certain snow clearance problems in the logistics zone.

The safety of all road users, particularly the elderly, children, visually impaired people, cyclists and those with physical disabilities should be considered. Adequate signs and warnings should be employed by delivery drivers and premises owners to make sure all vulnerable road users are not put at risk during delivery.

The height of the platform is 100–120 mm, level with the raised crossing. The logistics zone's total length should be 20 metres. This length is required to remove the need for reversing within the zone.

**Logistics zone for loading and unloading goods.**

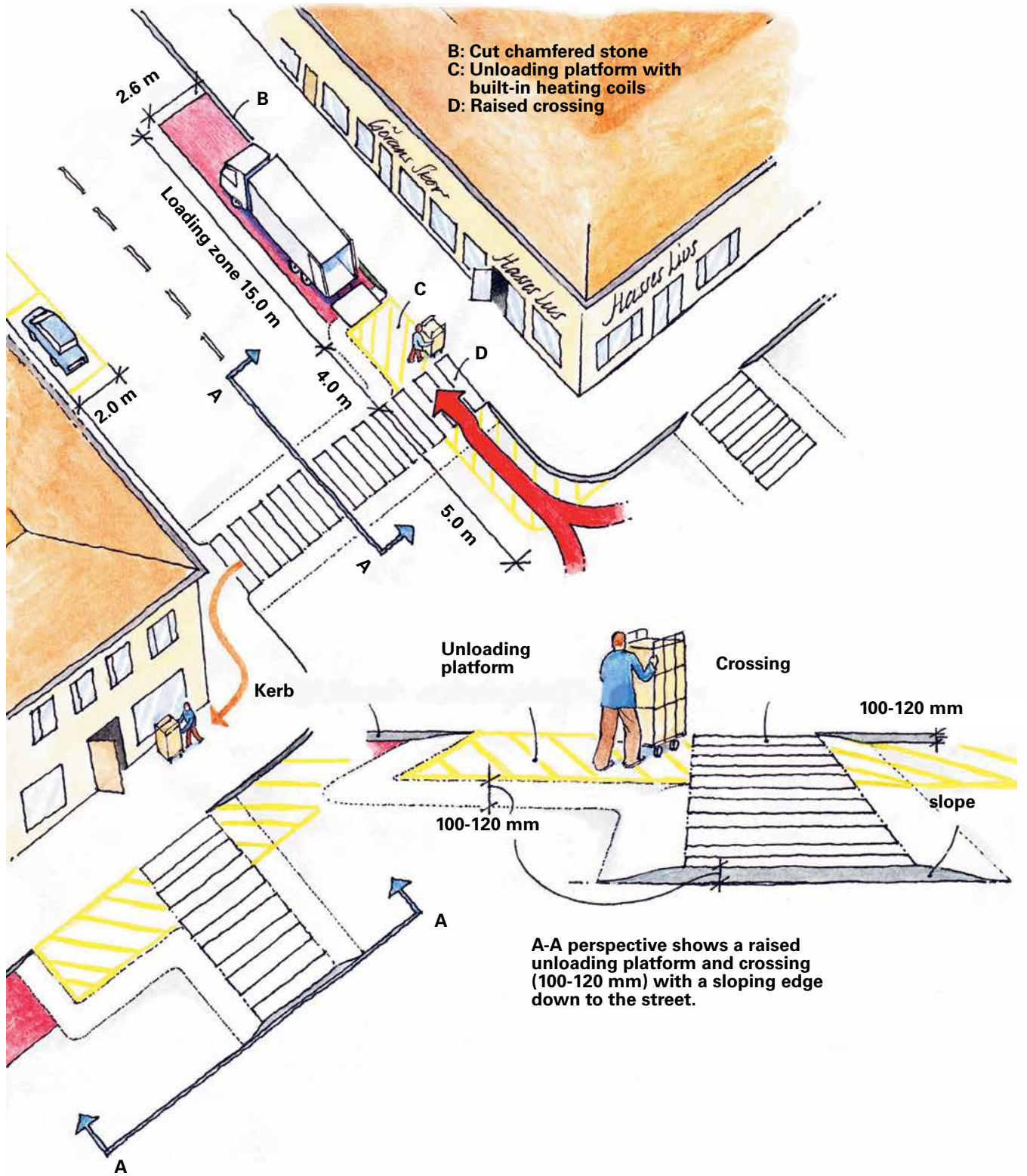

## 8.2 Example 2

This example shows how you can create a goods reception area in a limited space (for example, a courtyard) using a short dock leveller or in a protected or heritage environment using a loading dock lip. The vehicle's tailboard lift rests on the loading dock lip or is pushed in underneath the short dock leveller.

The loading dock lip solution is not used for new builds, but provides an option of using tailboard lifts in existing environments. Rolling goods handling is thus made possible.

Even if this solution is used, it is still important that there are no doorsteps in the goods reception area and doors can be kept open.

### Short dock leveller in a spatially restricted environment.

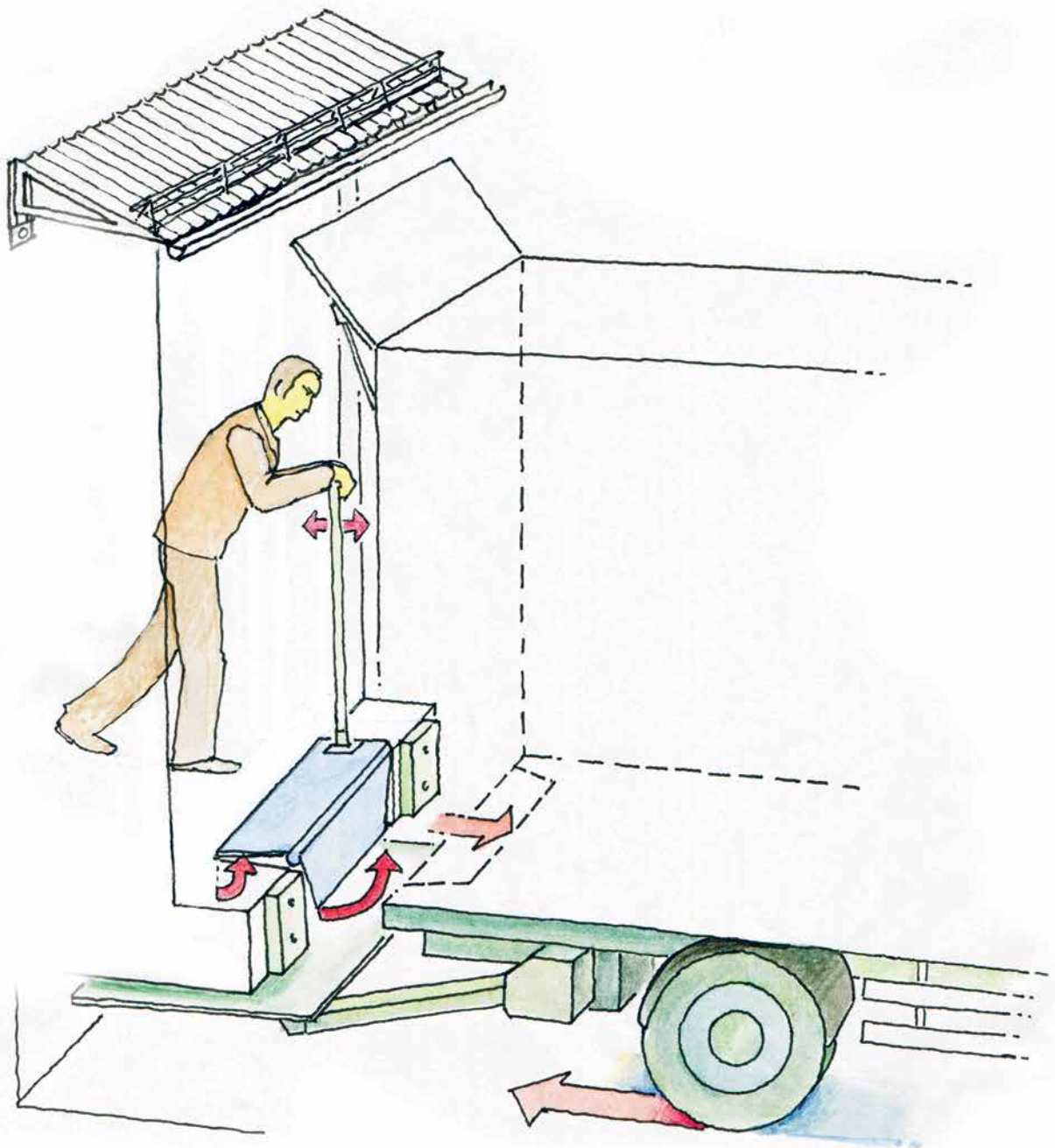

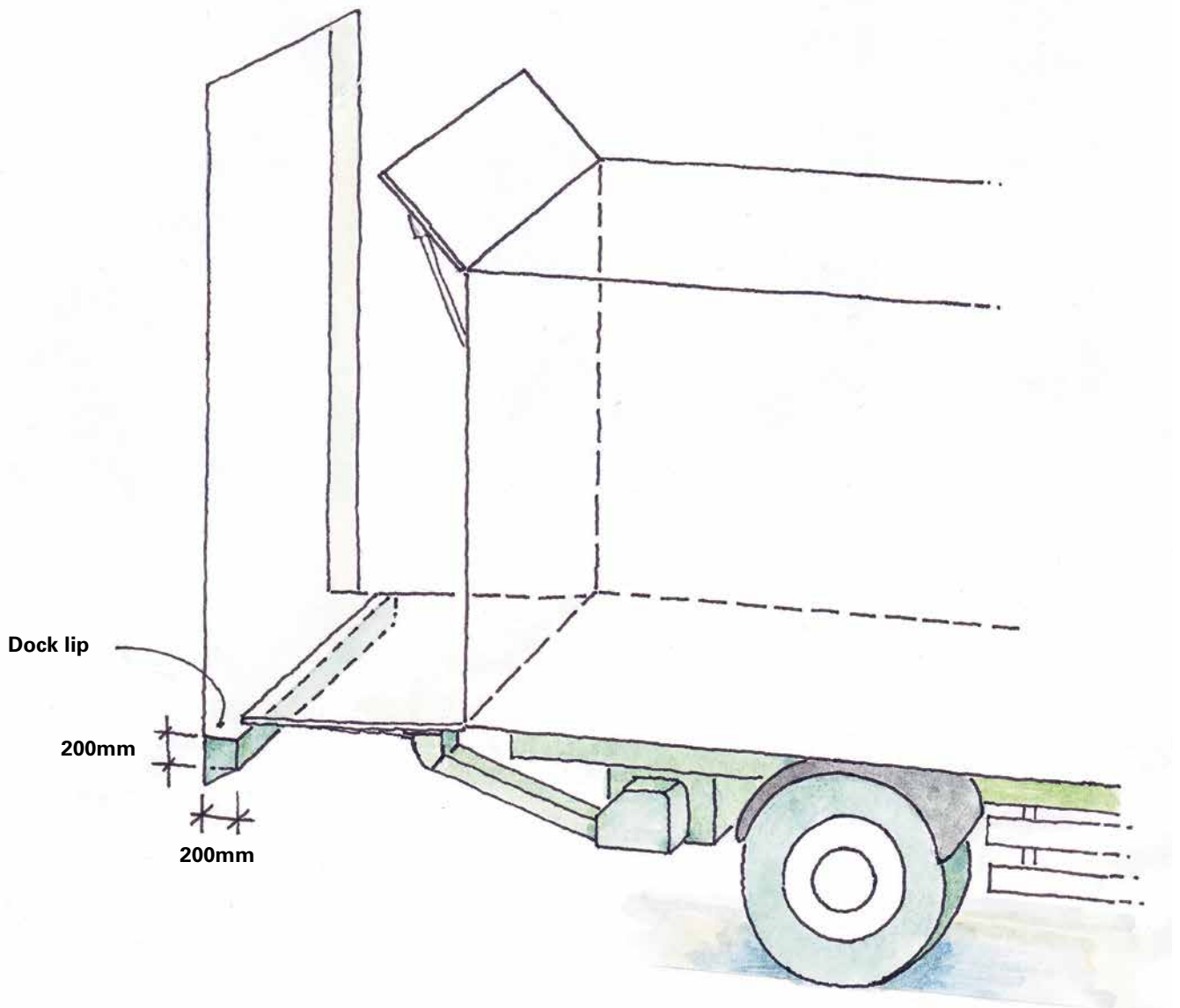
**Goods reception with loading dock lip in a spatially restricted environment.****8.3 Things to consider**

- Combustible material should be stored a safe distance from the industrial premises
- Goods and fractions that are to be taken away from the facility
- Risk of theft

## Chapter 4

# Key design considerations for goods reception elements

## 1. Goods reception design

This section deals with specific elements of goods reception design and highlights key considerations that are required to achieve safe and efficient operations.

For larger premises, the goods reception area is normally located within the boundary. The simplest goods reception design consists of an opening in the wall with a loading dock outside, apart from in those cases where goods reception takes place at ground level, which is usually under a canopy. Typically, to separate the outside climate from the inside climate, goods reception is cut off from the rest of the indoor environment by an air lock.

The purpose of a loading dock is to compensate for any difference in level between the vehicle trailer platform and the unloading area. A dock leveller is used to quickly connect the vehicle trailer platform to the loading dock and to even out any height difference between the loading dock and vehicle trailer platform.

Goods reception areas should not have doorsteps.



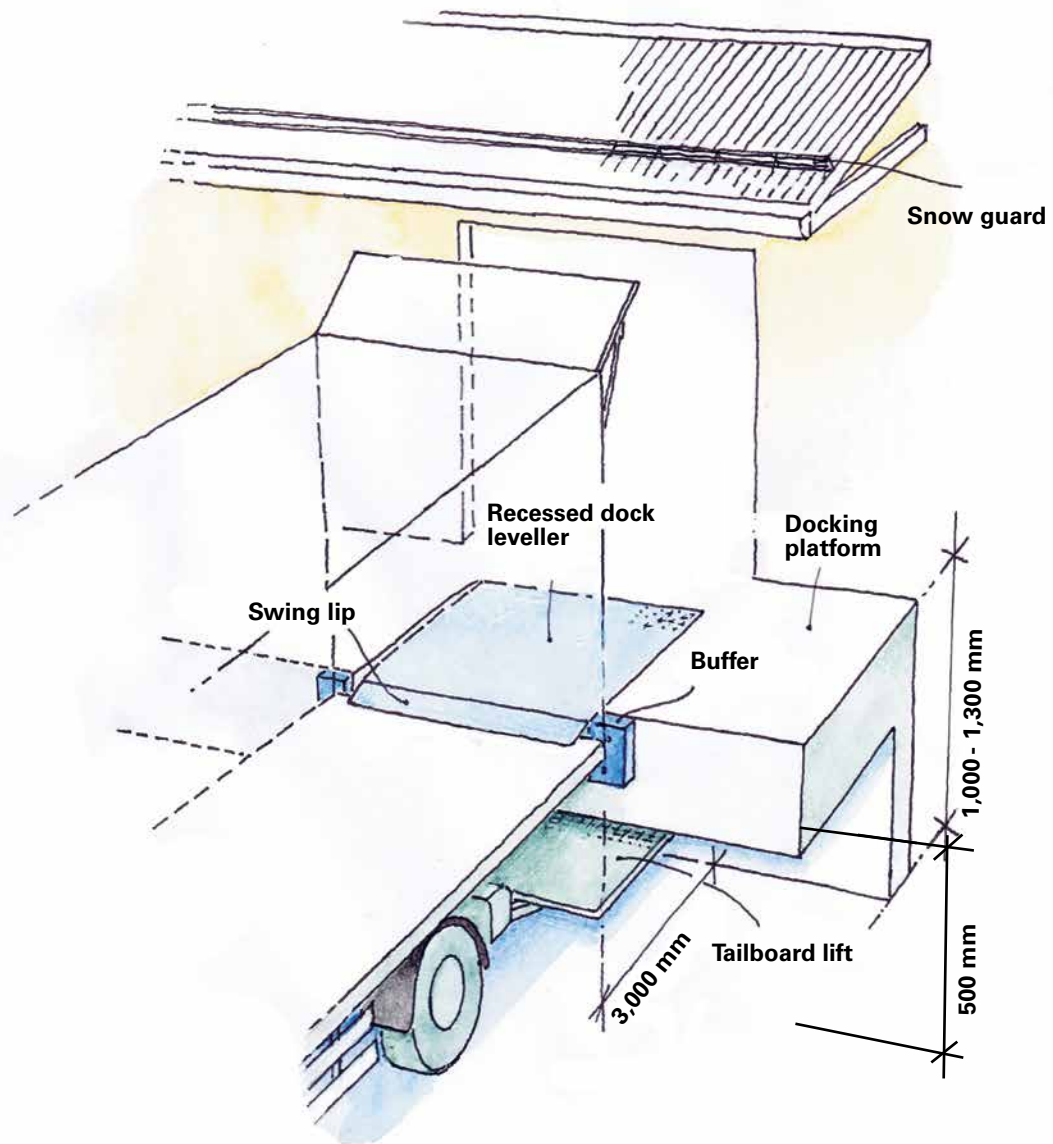

It should be possible to keep doors open. Combustible material should be kept in a lockable, fireproof store or at least six metres away from the building.



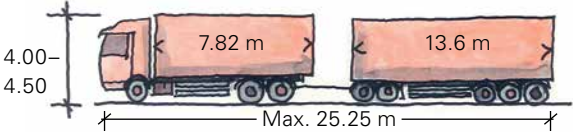
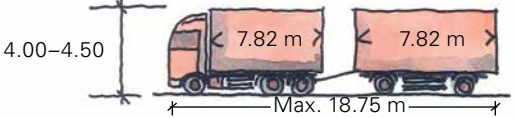
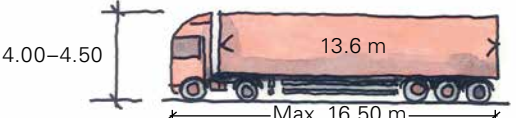

**Note:** There should be a railing at the edge of the loading dock.

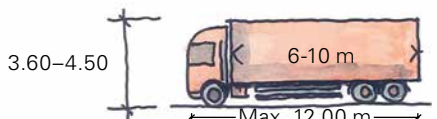
## 2. How to choose the best goods reception arrangement

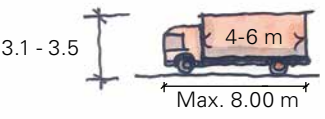
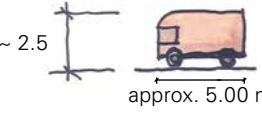
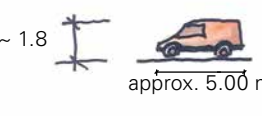
VEHICLE INFORMATION			
Illustration of vehicle	Vehicle type, designation <sup>1</sup> Gross weight in tonnes <sup>2</sup>	Vehicle length	Vehicle width <sup>3</sup>
	Road train approx. 60 tonnes	24.00–25.25 m	2.60 m
	Road train ≤ 40 tonnes	18.75 m	2.60 m
	Articulated vehicle ≤ 40 tonnes	16.50 m	2.60 m
	Motor vehicle ≤ 32 tonnes	8.00–12.00 m	2.60 m
	Motor vehicle ≤ 26 tonnes	8.00–12.00 m	2.60 m
	Motor vehicle ≤ 18 tonnes	8.00–12.00 m	2.60 m
	Motor vehicle (small truck)	6.00–8.00 m	2.20–2.60 m
	Light motor vehicle (delivery van) ≤ 3.5 tonnes	approx. 5.00 m	approx. 1.95 m
	Car, delivery van	approx. 5.00 m	approx. 1.60 m

1) The table specifies vehicle sizes that are prevalent in Europe. 2) Gross weight: Weight of load + vehicle. 3) Please note that vehicle mirrors extend beyond the specified widths. 4) Access to goods reception areas lower than 4.50 m must be signposted with the relevant vertical clearance, which must also factor in snow, ice and slope. 5) Vehicles with containers may have greater trailer platform heights, e.g. 1.45 m.

6) Also applies when reversing and driving along underground access passages, under canopies etc. 7) Read more about loading dock height dimensioning on page 28. 8) The measurement is calculated with regard to air suspension, snow, ice and slope. Vehicles with two loading levels may require higher vertical clearance.

		GOODS RECEPTION DESIGN		
Vehicle height <sup>4</sup>	Trailer platform height <sup>5</sup>	Goods reception type	Vertical clearance <sup>6</sup>	Loading dock height <sup>7</sup>
4.00–4.50 m	1.00–1.35 m	Bigger goods reception with hydraulic dock leveller	Vehicle's total height + 0.60 m <sup>8</sup>	1.00–1.35 m
4.00–4.50 m	1.00–1.35 m	"	"	1.00–1.35 m
4.00–4.50 m	1.00–1.35 m	"	"	1.00–1.35 m
3.60–4.50 m	1.00–1.35 m	"	"	1.00–1.35 m
3.60–4.50 m	1.00–1.35 m	"	"	1.00–1.35 m
3.60–4.50 m	1.00–1.35 m	"	"	1.00–1.35 m
3.10–3.50 m	approx. 0.70–0.80 m	Smaller goods reception with hydraulic dock leveller/manual dock leveller	"	0.70–0.80 m
approx. 2.50 m	approx. 0.40–0.60 m	Smaller goods reception with manual dock leveller	"	0.40–0.60 m
approx. 1.80 m	approx. 0.40 m	Weather-tight loading and unloading station	2.50 m	0 m

**General:**

Ground bearing capacity at goods reception: The ground in goods reception areas must be able to withstand the permissible axle load of 11.5 tonnes, boggie load of 19 tonnes and triple axle load of 24 tonnes by some margin. This is important to prevent permanent deformation and the formation of grooves that often occurs at e.g. bus stops.

Loading dock depth: The arrangement of goods, return goods, wheeled cages, pallets, etc. will determine the loading dock depth.

### 3. Loading house

To save floor areas indoors, reduce the risk of weather elements and ensure a good working environment during loading and unloading, the loading and unloading zone can be located outside by means of a loading

dock to which the loading vehicle can connect through docking. When the vehicle has docked, a dock seal will be activated that makes it possible for loading and unloading to take place protected from weather elements.

**Loading house. Cross-section.**

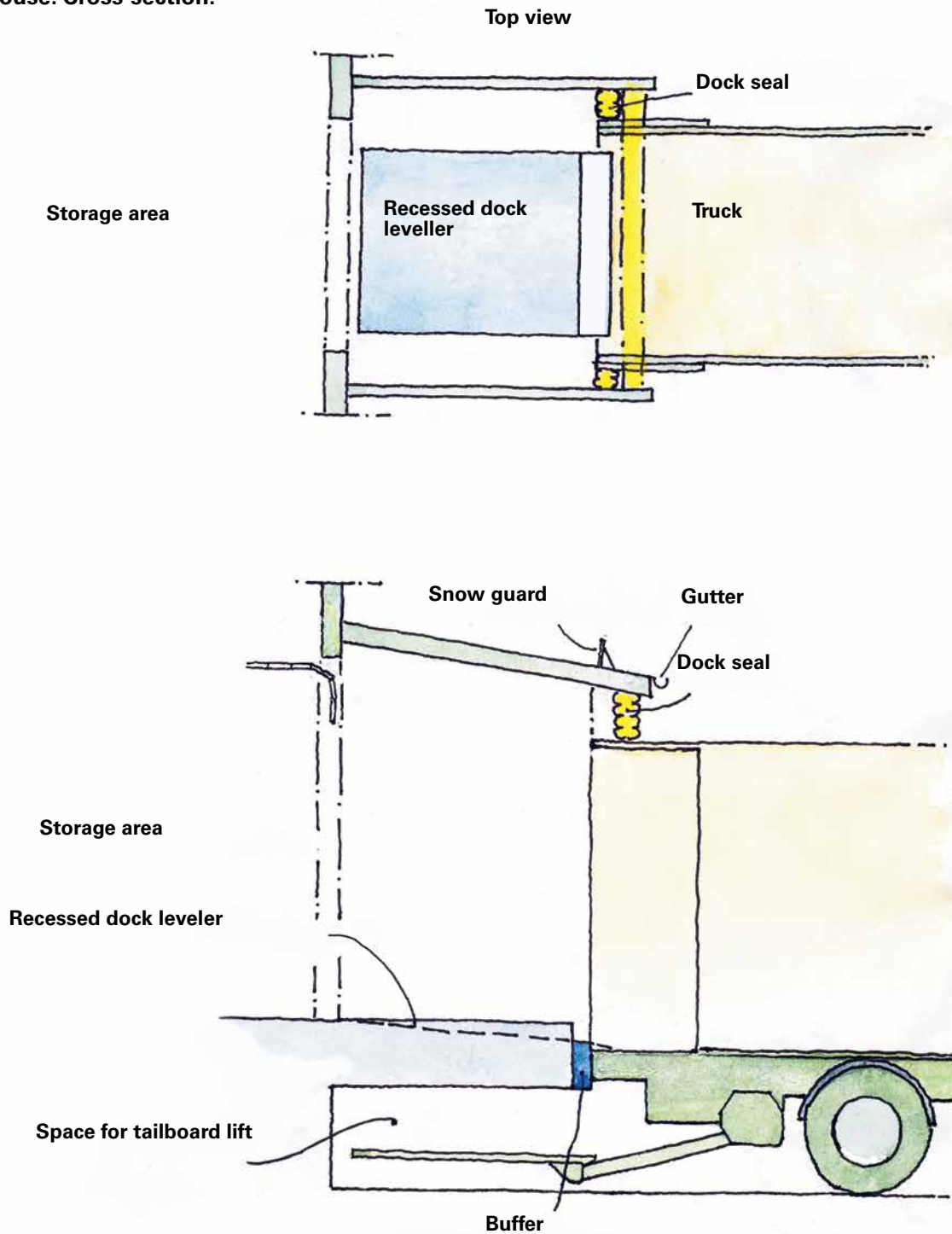

## 4. Gates

The most common types of gate used in the external wall are up-and-over or folding gates. The local situation determines your choice, in other words what the traffic is like and the layout of the area.

Please note that pedestrian and vehicle traffic should be separated by means of barriers, doors or gates. There should be a separate door for pedestrians next to gates for vehicles.

Up-and-over gates should be used for openings at loading dock height. Up-and-over or folding gates should be used for goods reception at ground level.

### 4.1 Types of loading dock gates

#### 4.1.1 Up-and-over gate

Gate that goes up to the ceiling on rails, adapted for existing spaces. The gate can be designed to either fold directly above the opening or to follow the wall without folding. The basic version of the gate is balanced and manual, and easy to motorise. It can be equipped with approved locks, windows and a pedestrian door. The gate should be installed on the inside of the façade. To improve safety and avoid personal injury, the up-and-over gate can be equipped with a red flashing warning light.

#### 4.1.2 Folding gate

Manual or electric gate that folds to the sides with two to eight panels at one or both sides of the opening. The gate should be automatically or manually lockable and be equipped with windows so that loading staff can see docking or undocking vehicles before the gate is opened or closed. The gate can be fitted internally or externally.

#### 4.1.3 Rapid roll gate

At ground level, these types of gate are often supplemented with rapid roll gates.

Using two interlocking gates – one always closed when the other is open – an air lock can be achieved.

### Storage area gates:

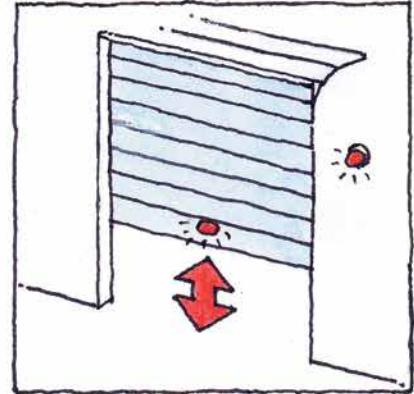

Up-and-over gate

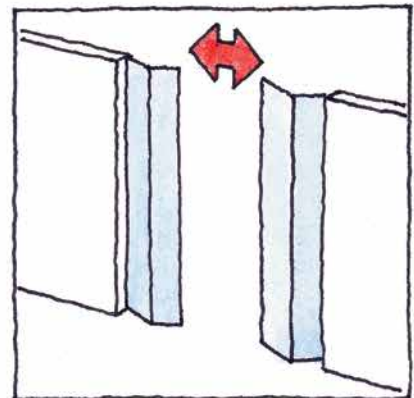

Folding gate

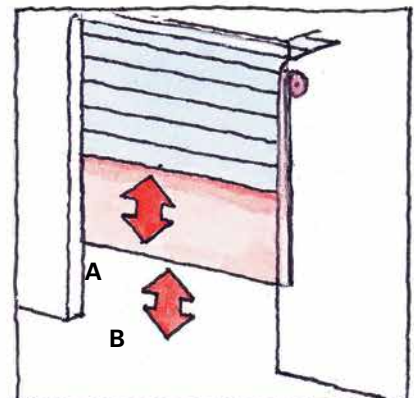

A: Night gate  
B: Rapid roll gate, daytime

#### 4.2 Openings requiring good insulation and rapid roll gates

For openings where you want good insulation, with as little draught as possible even during busy periods, a day and night solution or an insulated rapid roll gate may be appropriate.

#### 4.3 Day and night solution

A day and night solution is achieved by combining an insulated up-and-over gate with a non-insulated rapid roll gate on the inside or outside of the facade / building.

The rapid roll gate has a gate leaf made of fabric and opens at a speed of 1–2.5 metres per second. The rapid roll gates are often self-repairing or can be reset manually in the event of a collision.

When the up-and-over gate is opened, the rapid roll gate will be activated and remain active as long as the up-and-over gate is open.

The rapid roll gate will open and close quickly and prevent unnecessary draughts. When activity ceases, the up-and-over gate will be closed and the rapid roll gate will be deactivated. They can also be set so that if nothing comes through for 10–15 minutes the up-and-over gate will close and the rapid roll gate will be deactivated. The next time passage is required, the up-and-over gate will open and reactivate the rapid roll gate.

#### 4.4 Insulated rapid roll gate

The insulated rapid roll gate is always active and opens and closes just as quickly as a normal non-insulated rapid roll gate.

## 5. Gate dimensioning

**Width of gates for loading houses at different angles.**  
**The smaller the angle of the loading house, the wider the gate.**

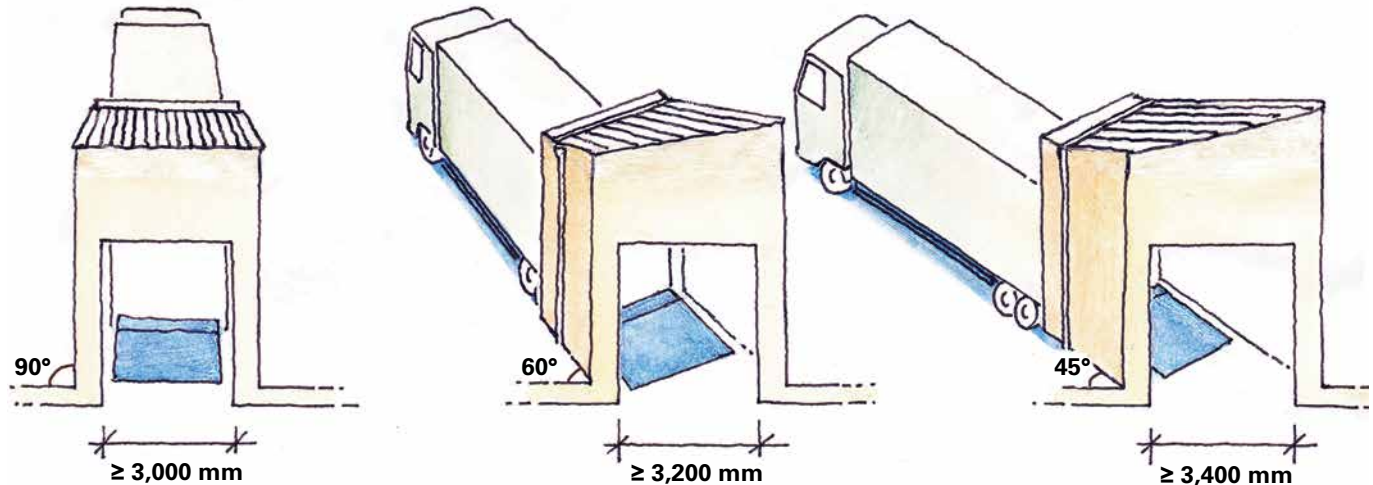

### 5.1 Gates for loading dock

To minimise damage to the gates caused by industrial trucks, a good gate height is at least 3600 mm. A greater height is required in the event of double stacked pallet handling. The following widths should be used:

- 90-degree docking system: at least 3000 mm
- 60-degree docking system: at least 3200 mm
- 45 and 30-degree docking systems: at least 3400 mm

The gate opening height is normally dimensioned based on the highest conceivable vehicle height with additional space to compensate for any slope.

Trucks are normally up to 4500 mm high (4000 mm international transport), which corresponds to vertical clearance in the road network. Gates for these vehicles are sized at 4000 x 5100 mm (width x height). This depends on the slope of the ground (see illustrations in Chapter 16.).

### 5.2 Gates at ground level for smaller vehicles

The following dimensions apply to gates through which smaller vehicles pass to load and unload goods indoors:

- Delivery vans with a height of 2500 mm normally require a gate opening of 3100 x 3600 mm (width x height).

- Small trucks with a height of 3100 mm normally require a gate opening of 3400 x 3700 mm (width x height). Small trucks with a height of 3500 mm normally require a gate opening of 3400 x 4100 mm (width x height).

### 5.3 Gates for passage at ground level

The following dimensions apply to gates used in goods reception areas where large vehicles pass through the premises:

- For passage at a 90-degree angle, the rule of thumb is that the gate opening width should be equal to the width of the vehicle plus approximately 2/3 of the vehicle's width.
- If the vehicle passes through at an angle that is not 90 degrees, the width should be increased.

**Note:** Consider the vehicle heights, based on the table in Chapter 4 section 2, during the design phase of the goods reception. Limited heights mean serious consequences for working environments.

## 6. Loading dock

When dimensioning the loading dock, think about different types of large vehicles (HGVs and large LGVs in particular) and how they can interact with loading dock height, dock levellers and other local conditions. Excessive differences in height between the loading dock and trailer platform are unsafe because they lead to a risk of slips, trips and falls as well as goods movement problems. A large difference in levels between the loading dock and vehicle platform cannot be compensated by using a dock leveller.

A normal height range for a loading dock is 1000-1350 mm, which corresponds to the trailer platform height of most large transport units. For some vehicles with low platform heights, the loading dock height should be adjusted. Certain goods reception areas may require several loading docks of different heights. Lifting platforms may be used in certain cases.

## 7. Dock leveller

A dock leveller is used to compensate for differences in height between loading docks and vehicle platforms. Tailboard lifts should not be placed on top of dock levellers.

Dock levellers are available in different lengths and widths, and can be equipped with different lip designs. The most common lip designs are 'swing' and 'telescopic'. A dock leveller that is 2500 mm long can tolerate a height difference of  $\pm 250$  mm between the vehicle platform and loading dock. There should be space for the vehicle's tailboard lift under the dock leveller.

**For safety reasons, dock levellers with automatic return should never be used.**

Many serious personal injuries have occurred to drivers and operatives who were crushed or trapped between motorised handling equipment (such as hand pallet trucks) and automatic dock levellers.

A dock leveller should not slope too much, which is why the length of the dock leveller should increase in proportion to the difference between the lowest and highest vehicle platform height. The dock leveller's maximum gradient should be 8.3% (1:12) for manual handling operations and maximum 10% (1:10) when it is used as an access route, for industrial lift or pallet truck traffic.

**Clear arrow markings on control equipment for the relevant dock.**





7.1 Swing lip and telescopic lip and dock leveller

Dock levellers are normally 2500 mm long, which allows the height to be varied in relation to different trailer platform heights.

A length of 2500 mm accommodates most vehicle tailboard lifts, to be fitted underneath the docking platform during loading/unloading operations.

7.1 Swing lip and telescopic lip and dock leveller

Consideration	Action / Attention
<b>Load capacity</b>	Dock levellers with load capacity of 6, 9 and 12 tonnes or more.  Static load when calculating total load on dock leveller; i.e. the forklifts truck's tare weight, pallet, driver and cargo weight.
<b>Lift trucks</b>	Lift trucks with narrow wheels may deform the dock leveller's diamond plate
<b>Width</b>	Should be at least 2200 mm
<b>Smallest contact surface for the lip</b>	Should be no less than 100 mm
<b>Swing lip</b>	It is the most common design and provides a smooth transition. Difficult to use when arriving goods are located at the far end of the vehicle platform: It could damage the goods
<b>Telescopic lip</b>	Provide a smooth transition between the dock leveller and lip. This procedure results in less strain on materials and people's backs. Specially designed lips made of steel or aluminium are available to create a smooth transition between dock leveller and vehicle platform.
<b>Non-skid surface</b>	It can be applied to the dock leveller. The compound has a sound-absorbing effect.

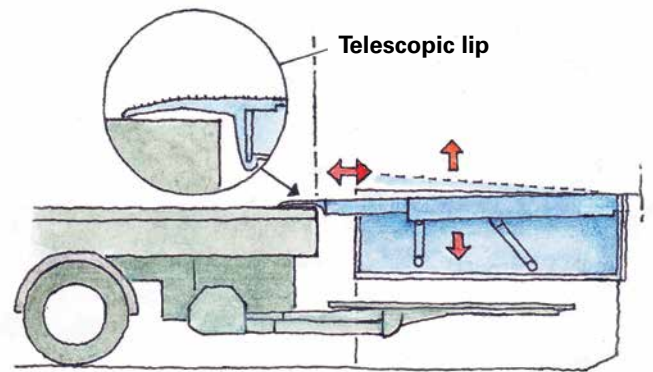
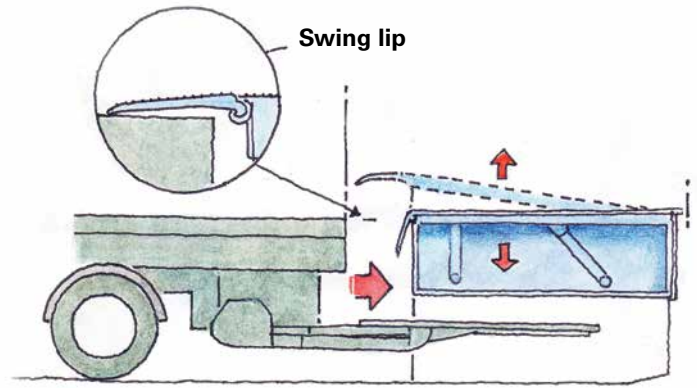

Swing lip and telescopic lip on dock leveller.

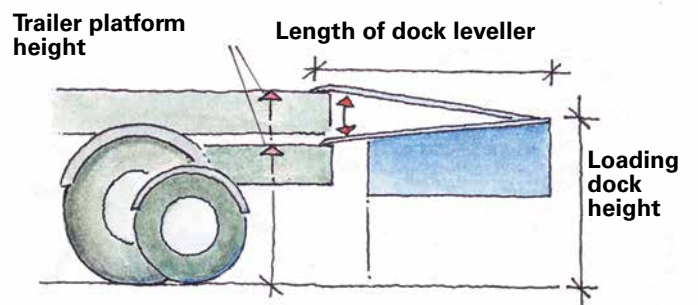

**Dock leveller formula**

The gradient as a percentage is calculated as follows:

$$\frac{(\text{Vehicle trailer platform height} - \text{loading dock height}) \times 100}{(\text{lengths of dock leveller} + \text{lip})}$$

## 8. Safe docking

When a vehicle arrives at a goods reception, it is important for safety reasons that the vehicle is docked in the following order:

- a) Position the vehicle securely next to dock leveller
- b) Activate dock seal
- c) Switch on interior lighting in goods reception
- d) Open gate
- e) Move dock leveller into work position when a vehicle leaves goods reception.

***These steps should then take place in reverse order.***

This applies when loading and unloading via the vehicle's rear doors. For side loading, there are different solutions involving hydraulic bridges equipped with longer telescopic lips (up to 1000 mm long).

The gate is normally fitted on the inside of the wall and the loading system controls are inside the gate. The controls should be located close to the gate so that the risk area can be monitored. If the gate is closed, it should be equipped with a window or "peephole". There should be lighting inside the loading house. If these safety features are not in place, the gate and dock leveller should be interlocked so that the dock leveller cannot be moved until you have full view of the dock leveller.

There are different types of "smart" control systems that activate the loading system functions in the correct order: dock seal, gate, dock leveller.

These systems may also have outputs to a computer system, automatic troubleshooting and user logging. The controls can be adjusted to suit user requirements.

**For safety reasons, dock levellers with automatic return should never be used.**

Many serious personal injuries have occurred to drivers and operatives who were crushed or trapped between motorised handling equipment (such as hand pallet trucks) and automatic dock levellers.

## 9. Ramp

When small differences in height occur, a ramp can be used. A ramp should have an incline of maximum 1:12 and a maximum height of 0.5 metres between the loading dock and the vehicle platform for manual handling. If the incline is greater than 1:12, then motorised lift trucks may be necessary. It is strongly recommended that you consult the forklift manufacturer before using a ramp with an incline greater than 1:12.

## 10. Dock seals

Dock seals are used to protect workers from weather conditions, as well as for transport that require unbroken temperature chains. They enclose the vehicle when it has been reversed up to the dock.

It is recommended to use inflatable dock seals with good sealing capacity when working in severe weather conditions.

By using the vehicle's air suspension the load platform can be lifted into position when docking. Therefore dock

seals should be higher than the measurement used as the vehicle's vertical clearance for the road, i.e. 4500 mm. The dock seals' normal maximum reversing height should therefore be at least 5100 mm and the lowest height against which they can seal is 2900 mm.

Delivery vans are often low and the docking procedure above does not apply to them. Tailboard lifts can be used instead for loading and unloading low vehicles, subject to vehicle and tail lift manufacturer's recommendations.

### Dock seal.



### 11. Step bridges

There are also loading dock configurations that allow the vehicle doors to be opened after it has been reversed towards the platform and the dock seal has been inflated.

This means reversing with the doors open is avoided, an action that is risky due to impaired vision and the fact that goods might fall out. Loading docks with a platform equipped with a step are also useful when an unbroken temperature chain is required.

**Loading house with step bridge, allowing an unbroken cold chain.**



**Loading house with the option of opening the vehicle's rear doors inside the loading house. Layout sketch top view.**

**Loading house with the option of opening the vehicle's rear doors inside the loading house.**

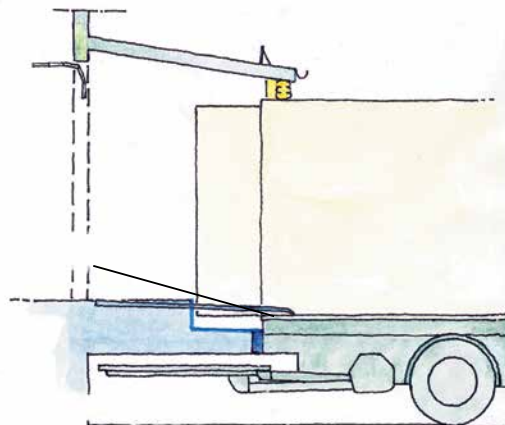
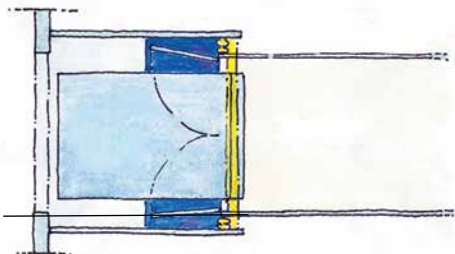

**Note: Space for opening doors**

**Note: Space for opening doors**

## 12. Securing a vehicle or load carrier

The dedicated driving area is normally structured so that the ground slopes away from the loading dock with a minimum gradient of 1:100. To prevent vehicles at dock levellers from rolling, the ground may slope 1:100 towards the dock (which requires drainage to be taken into consideration). Vehicles or load carriers should always be secured to the dock leveller if motorised handling equipment or forklifts are being used to move goods via the dock leveller to or from vehicles or load carriers.

In addition to an activated parking brake, the vehicle or load carrier floor should be equipped with suitable loops or other devices for securing the vehicle to the dock leveller using straps, which is a more secure method than chock blocks. Drivers of motorised handling equipment or forklifts should make sure that the vehicle or load carrier is secured to the dock leveller and that the load carrier floor is dimensioned for the motorised handling aid being used.

### Securing a vehicle to a dock leveller using straps.

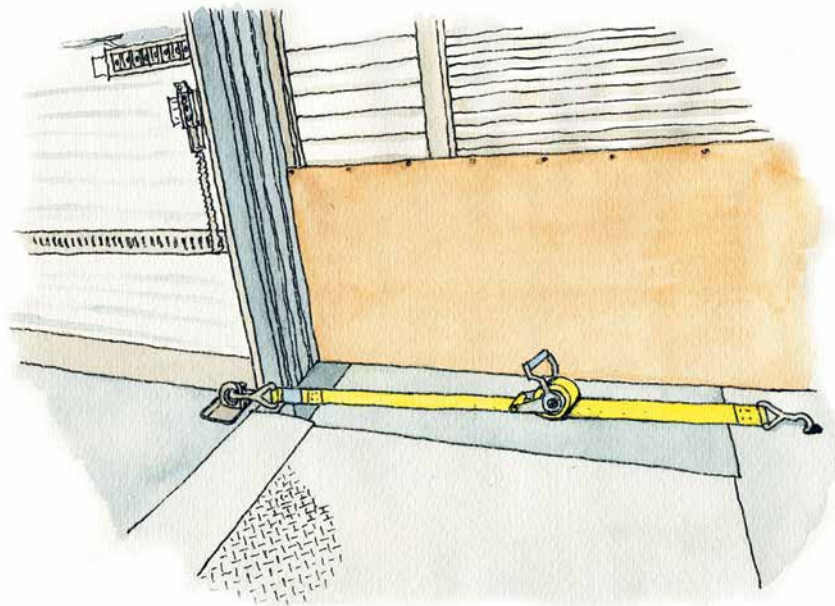

### Securing using mechanical tensioning device with release alarm and interlocking of dock leveller.

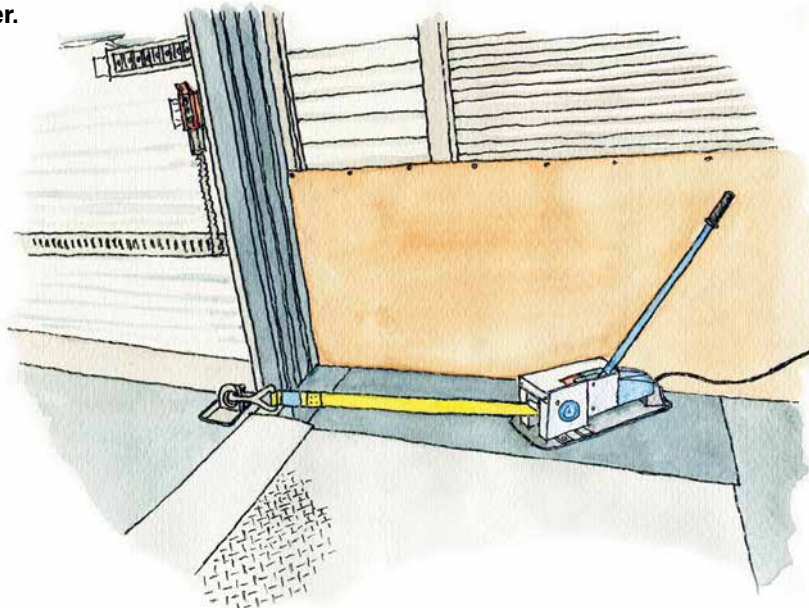

### 13. Inspection and maintenance

Gates should be certified, inspected and approved by the relevant authorities according to national legislation and standards.

In the European Union, gates should be CE-marked and satisfy the safety requirements in the standard EN 13241-1. For electric gates, the EU Machinery Directive also applies if there are additional risks not covered by EN 13241-1.

Electric gates should be inspected and maintained in accordance with manufacturer's provisions.

Gates should be inspected after installation if this is not included in the CE marking. The gate should be regularly serviced (at least once a year) by trained competent staff in accordance with the manufacturer's instructions. Servicing of the gates should be logged. Gates should be inspected every two years or based on manufacturer's instructions.

Hydraulic dock levellers should be CE-marked and satisfy the safety requirements in EN 1398; they should also be inspected and maintained in accordance with manufacturer's provisions.

Dock levellers should be serviced in accordance with the manufacturer's instructions, but at least once a year. Maintenance should be documented. Dock levellers should be inspected every two years.

Self-inspection should also be carried out.

### 14. Handling equipment

Transport hazards that exist in the workplace must be assessed and appropriate steps taken to eliminate or reduce any risks found.

Transport operations involve a significant risk of incidents and accidents involving moving motorised equipment and handling equipment. To prevent risk it is crucial to make sure that the correct handling equipment is available and that it is used correctly.

The selection of handling equipment should be guided by an analysis of factors such as size, weights, number of pallets or goods to be moved, travel distance, moving frequency and any lifting heights.

Stakeholders need to focus on prevention. A risk assessment should be carried out before the selection and use of handling equipment.

Handling equipment is extremely useful, as long as it is used safely and appropriately by operators who are appropriately trained and competent.

Handling equipment can be dangerous. Many workplace accidents involve people being hit or run over by forklift trucks (typically when the forklift is reversing) because the driver did not see them. Due to their size and weight, injuries resulting from forklifts are generally very serious. Accidents are often caused by poor supervision and a lack of training.

Handling equipment may be powered trucks used to carry, lift, stack or tier materials, pallet trucks, rider operated forklifts, fork trucks, or lift trucks. They can be powered by electric battery or combustion engines.

Employers must make sure that forklifts are provided in a safe condition for use at work. This can be achieved by having a preventative maintenance system which includes scheduled checks as per the manufacturer's instructions.

Before motorised handling equipment is used on vehicles or a load platform, drivers and loading and unloading staff should check that the ground is stable and that the vehicle load platform is secured to the dock leveller and will not tip or move. Anyone operating forklifts should have the necessary training, authorisation and skills to drive this type of truck.

### 14.1 Electric pallet low-lift or high-lift truck and forklift truck

A so-called low-lift truck is an electric truck designed for horizontal transport and slight slopes. It offers improved ergonomics and increased productivity.

A motorised pallet lift reduces the strain on the arms, shoulders and back.

An electric pallet low-lift truck is simple to manoeuvre and can be used in smaller warehouses and distribution vehicles where pallets need to be moved. It is compact, stable, easy to use and requires very little maintenance.

An electric pallet high-lift truck can be used in smaller warehouses for various pallet movements including horizontal transport, stacking and loading into vehicles. It may be useful to carry an electric pallet high-lift truck in the vehicle for simple loading and unloading in different distribution systems.

When an electric pallet high-lift truck is used correctly, the need for many manual lifts is removed in both warehouses and distribution vehicles, thereby improving both ergonomics and productivity.

Note: Check the bearing capacity of the vehicle trailer platform, the load carrier's connection to the dock leveller and the function and stability of any support legs before any industrial trucks are driven across into the vehicle.

### 14.2 Low-lift rider truck

When frequently used to load and unload vehicles, forklift trucks need to be equipped with protecting devices for the driver.

On an electric pallet low-lift truck the driver is protected from jolts to their feet and legs during the loading and unloading of vehicles.

Having the driver's cab at a 45-degree angle gives a view both to the front and rear, ensuring better ergonomics.

**Low-lift truck with rider.**

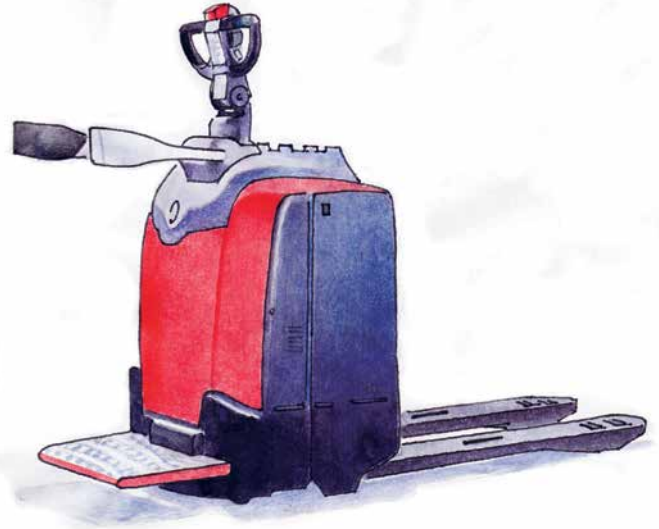

**High-lift truck with rider step.**

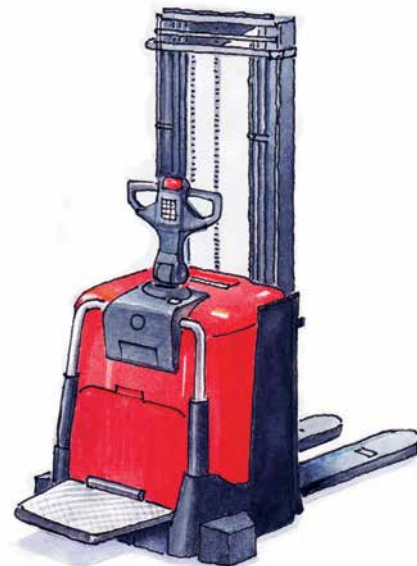

**Low-lift rider truck at 45-degree angle, facilitating rear view.**

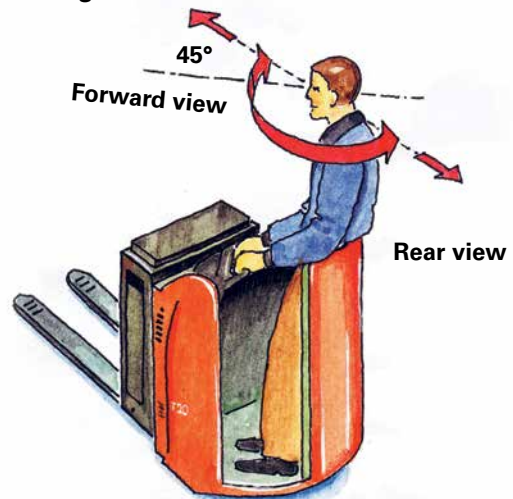

### 14.3 Forklift truck

The forklift truck is a normal type of truck where the driver sits and drives the vehicle. It is used widely, for example in warehouses and depot environments, and the forklift truck has a good lifting capacity.

Employers must make sure that drivers are familiar with the vehicle they are driving and that they have been given appropriate instruction, information and training to carry out required pre-checks and operate the forklift in the correct and safe manner.

**Forklift truck.**

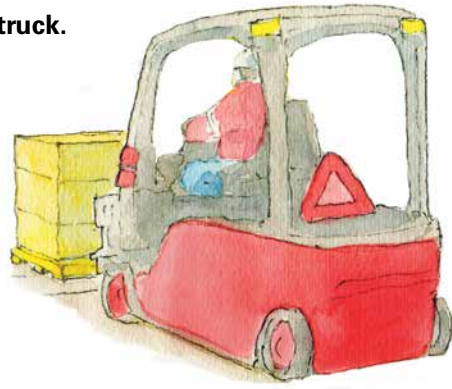

### 14.4 Lifting truck/pallet lift

A manual lifting truck or pallet lift is appropriate for goods handling on flat surfaces and for less frequent handling.

The most difficult part of working with a loaded lifting truck or pallet lift is getting it to move. A significant and positive difference will be made to the working environment if employees learn how to use this aid correctly by pulling the lifting truck or pallet lift gently using their leg muscles instead of straining their back.

For more frequent goods handling, motorised lifting trucks or pallet lifts can be used. This eliminates strain on the arms, shoulders and back when moving the goods. A lifting truck or pallet lift is simple to use, requires very little maintenance and can result in both improved ergonomics and increased productivity.

A lifting truck with large wheels dampens vibrations, which means the lifting truck can overcome minor obstacles with ease. Even road verges and kerbs can be tackled. The strain on the driver is reduced thanks to the electric drive motor and lift motor in combination with the wheel setup and an ergonomic control arm.

A hand truck is better from an ergonomic perspective when handling parcels. With the load on the hand truck, it is easier to navigate the level differences between e.g. the street and the kerb.

Getting a hand truck with goods up staircases can strain drivers arms, shoulders and back. However, there are small and easy-to-use electric stair-climbers intended for quick transport up both straight and curved staircases.

Goods reception areas should not be designed in such a way that stair-climbers are required. The stair-climbers are only to be used where goods handling is not part of regular activities, such as when making home deliveries. A stair-climber can be used for transporting different types of goods. A battery on charge in the vehicle – so one battery for the hand truck and one in the charger for quick replacement – will make sure deliveries are made quickly.

**Lifting truck.**

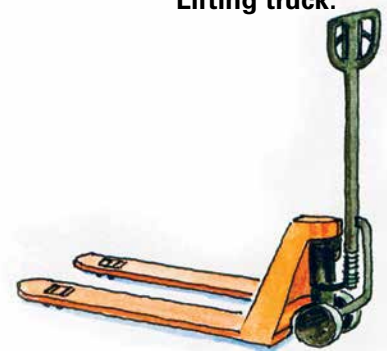

**Electric lifting.**

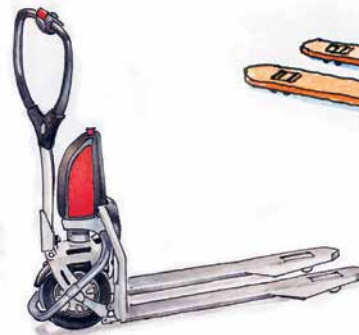

**Lightweight hand truck.**

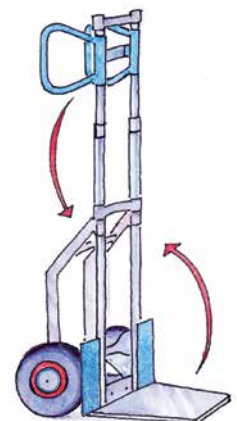

**Stair-climber.**

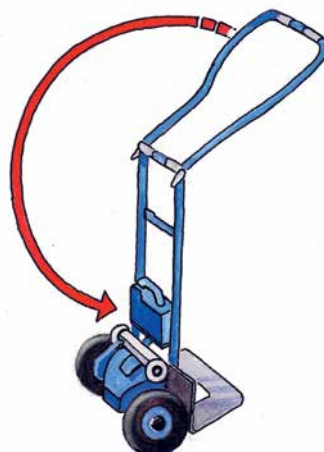



## 15. Traffic management

Vehicles and trailers need a lot of space to manoeuvre safely. This is why access routes should be planned with workplace transport safety in mind. In general for left hand drive vehicles, it is recommended to plan left hand turns and vice-versa for right hand drive vehicles – in order to mitigate blind spots while manoeuvring. Different types of traffic should be separated from each other and, most importantly, separated from vulnerable road users and pedestrians.

Access routes to goods reception areas, as well as driving areas, should be planned so that reversing is avoided or minimised. Vegetation around access roads and driving areas should be designed so that it does not block the driver's view, depending on the season. Driving areas should also be planned so that they facilitate safe driving behaviour, good drainage, lighting, signs, vision and ice and snow clearance.

### 15.1 Vehicle routes

When a vehicle is reversed up to a loading dock, vehicles should only use designated and signposted vehicle routes. Routes will vary depending on vehicle dimensions. Premises should set out one-way systems to remove the risks of injury and collision from reversing vehicles. If reversing is unavoidable due to premises constraints, then this should be done safely, and in a designated area

for reversing. The area in front of a loading dock should allow for sufficient space for parking of other vehicles, and should allow sufficient space for the driver to exit the vehicle cab and make their way to the driver refuge.

For a loading dock at a 90-degree angle to the dock, it is recommended that the vehicle path should correspond to twice the length of the vehicle.

Therefore, a 25.25 m vehicle combination requires 50.00 m of free space in front of the dock, plus space for walking, exiting the vehicle and parking. There should be suitable reversing lines to facilitate reversing to a loading dock, and the distance between vehicles should be approximately 1.5 m, allowing the rear doors of the vehicle to be opened before it docks with the loading house.

#### 15.1.1 Vehicle routes for 25.25 m vehicle combinations

Easy driving can be achieved by ensuring an outer radius of 15 metres\* and that the space outside the vehicle route is kept clear of obstacles. The goods reception area should also have the same loading capacity - single/boggie/triple axle loads - as the vehicle route.

\*Directive 96/53/EC amended by Directive 2015/719/EC indicates a swept circle having an outer radius of 12.50 metres and an inner radius of 5.30 metres.

**Truck with trailer or dolly with semitrailer, 25.25 metres.**

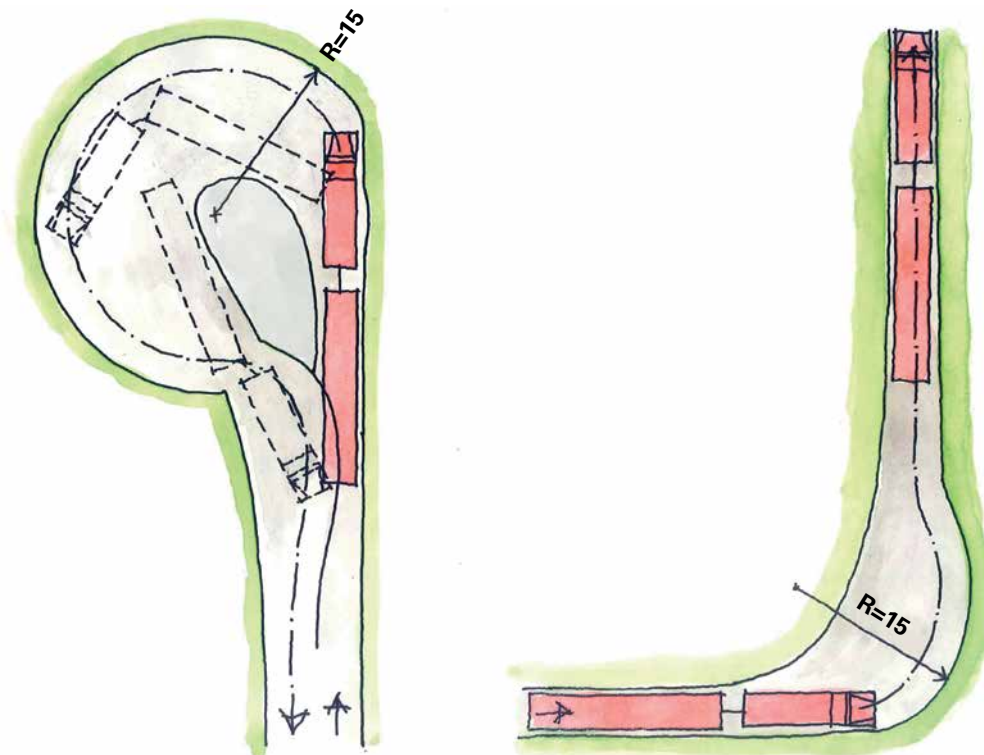

### 15.1.2 Vehicle routes, 360° and 90° turns

**Note:** that vehicle routes may vary depending on the vehicle design, wheelbase, varying loads and ground surface.  $R=12.5$  metres.

**Swept paths may vary depending on the vehicle manufacturer, wheelbase, loads, ground surface, etc.**

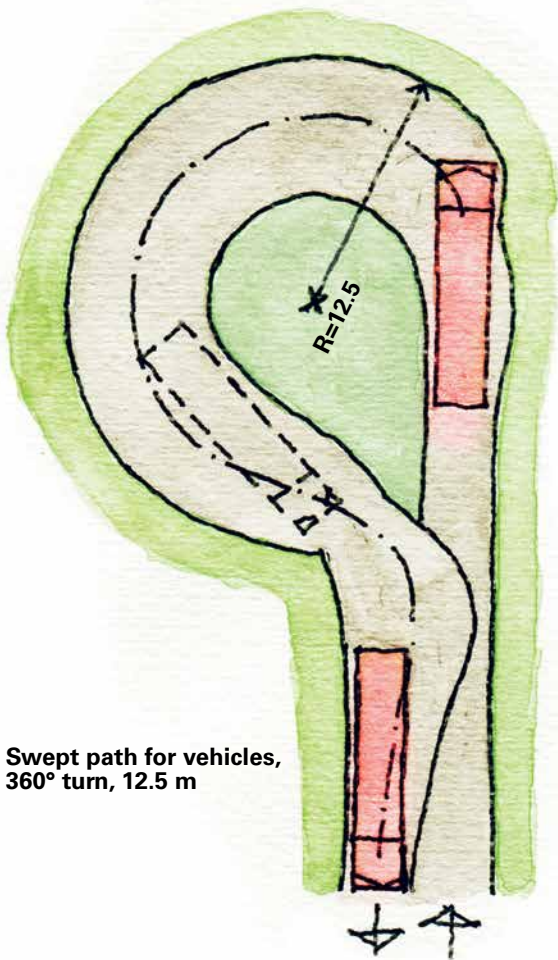

Swept path for vehicles,  
360° turn, 12.5 m

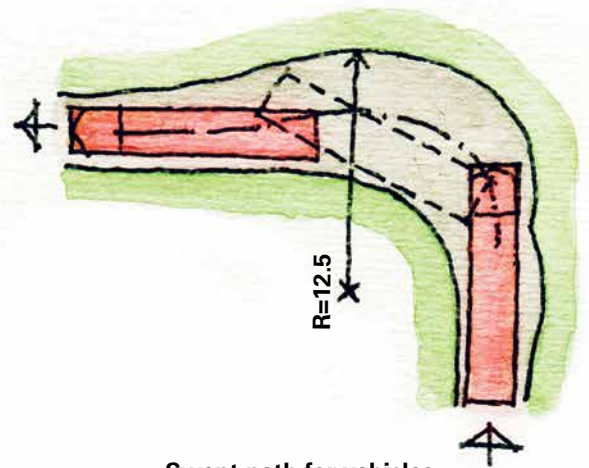

Swept path for vehicles,  
90° turn, 12.5 m.

15.1.3 Vehicle routes, street corner test 90°

The inner radius should be empty of obstacles for easy manoeuvre of vehicles.

**Note:** that 15 metres for the outer radius is recommended for easy manoeuvre of vehicle combinations.

**Swept path, street corner test.  
Rigid truck with full trailer.**

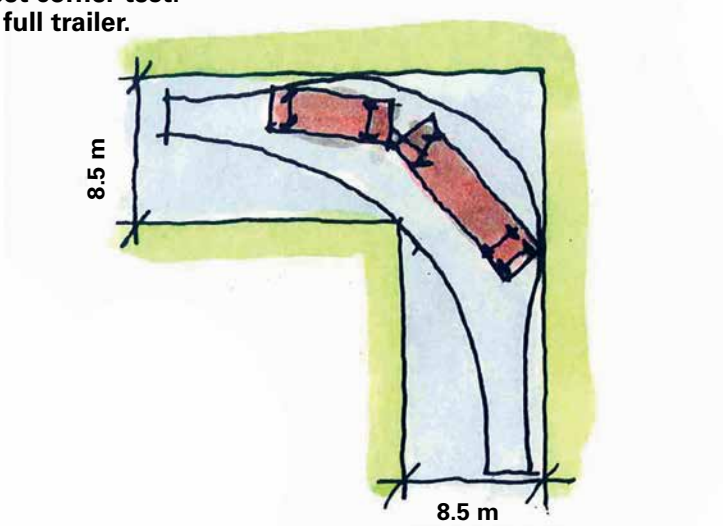

\*Directive 96/53/EC amended by Directive 2015/719/EC indicates a swept circle having an outer radius of 12.50 metres and an inner radius of 5.30 metres

**Vehicle route, international vehicles combination with 18.75 m vehicles length.**

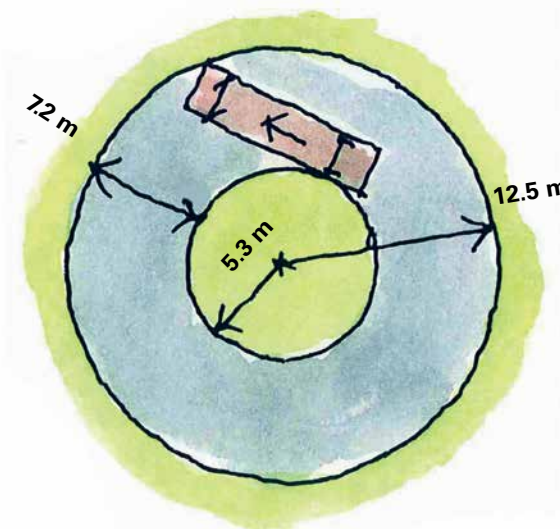

Swept path, international vehicles, 18.75 metres.

**Vehicle route, modular vehicles combination within 25.25 m vehicles length.**

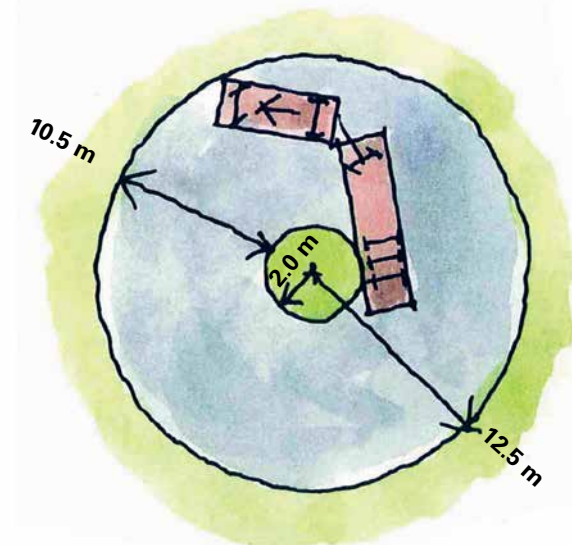

Swept path, modular vehicles, 25.25 metres.

## 16. Moving between different slopes

In cases where there is limited space in front of loading docks, the loading docks can be angled to reduce the vehicle route in front of the loading docks. If the loading docks are angled, the gate width should be increased.

When planning vehicle parking bays with level differences, remember that a vehicle requires more vertical clearance on a slope than on flat ground as well as when moving between different slopes.

When moving from a flat surface to a downwards slope, the vehicle's overhang will be raised. In the reverse situation, when moving from a flat surface to an upwards slope, the vehicle's middle section will be raised.

Note that installations and signs suspended from the ceiling may encroach on a vehicle's manoeuvring space and that an empty vehicle is higher than a loaded vehicle.

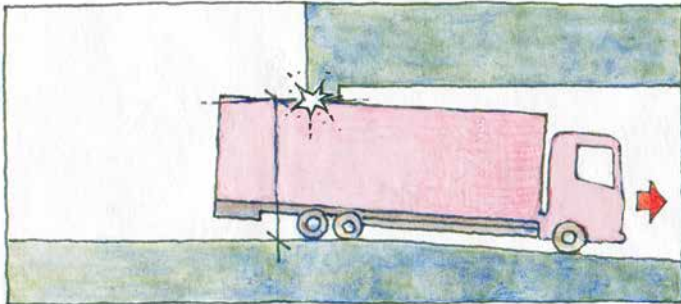

1. When driving down a ramp into a building, i.e. downhill, the vehicle's overhang will be raised.

2. When moving from a flat surface to a downwards slope, the vehicle's overhang will be raised.

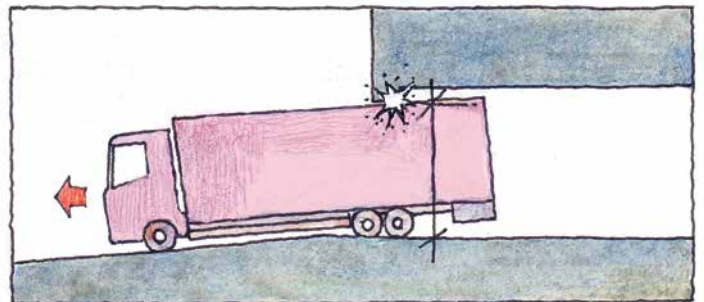

3. When moving from a flat surface to an upwards slope, the vehicle's middle section will be raised.

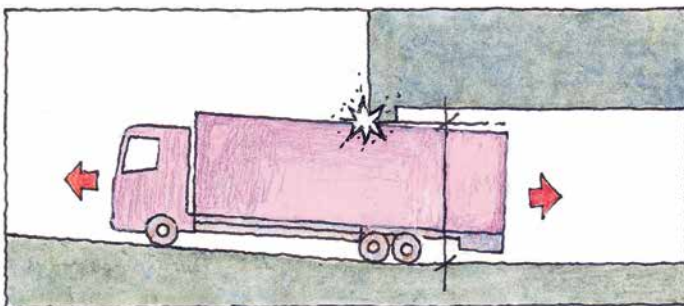

4. When the goods reception approach is on a slope, remember that vehicles might damage the goods reception's façade or canopy when reversing.

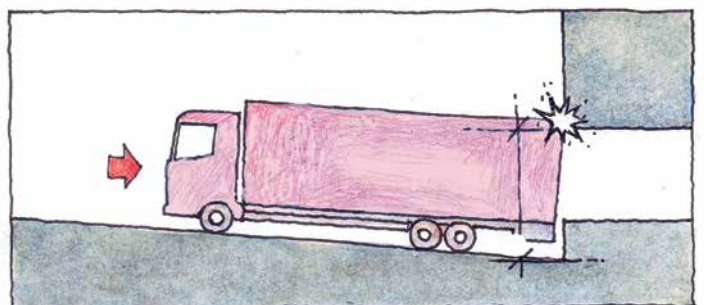

## 17. Help reversing

To facilitate safe reversing, it is important that loading docks look like they are angled to the left in relation to the façade when the driver looks in their left rear-view mirror when reversing.

### 17.1 Limited visibility at goods reception

- The docking system should be lit using external lighting.

Note that any risk of glare should be avoided. The closer together vehicles are parked, the better the lighting between the vehicles needs to be, even at dusk.

- Yellow reversing lines provide guidance for the drivers and permit safer reversing.

The reversing lines should align with the vehicle tyres, not with the outer edge of the trailer. It is also a good idea to have distance markings on the ground to help the driver judge the distance when reversing up to a loading dock.

- Reversing lines may be difficult to see if they are covered by snow, worn away or it is dark outside.

To facilitate reversing, visual support can be provided to the driver using lights mounted on the front of the docking system that indicate the position of the reversing lines.

- The distance between the reversing lines should be at least 700 mm for the driver to be able to move around in the loading and unloading area.

**Note** that this is a minimum measurement. The desired distance between the vehicles – and the reversing lines – should be significantly greater. At least 1,500 mm is required between the vehicles to allow the vehicle's rear doors to be opened and to facilitate reversing by improving the rear view.

- The white lights can also be supplemented with red lights.

The lights also function as stop lights, since they switch to red when the load carrier has reached a position where it can park in front of the docking system.

### 17.2 Saving energy and increasing safety at goods reception

- The dock leveller gate can be interlocked so that it cannot be moved until the truck is in position.

A light signal can also be set up inside to indicate when a vehicle is in position in the loading house.

- Further technical help to prevent accidents in connection with reversing is available and should be used.

There are electronic sensors that can be mounted to loading docks that detect whether someone is moving in the reversing area. Corresponding functions designed to be mounted on the rear of trucks have been developed.

#### Reversing and stop lights.

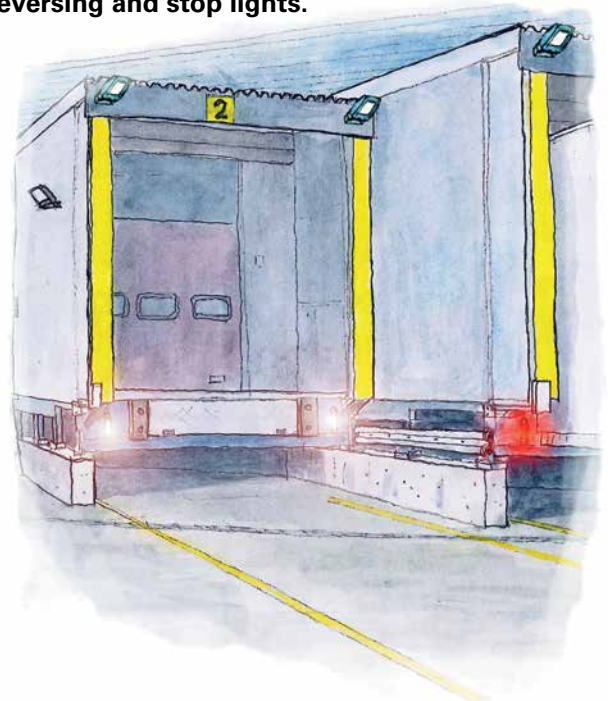

17.3 Help reversing

Swept path in dedicated driving space when reversing towards a loading dock.

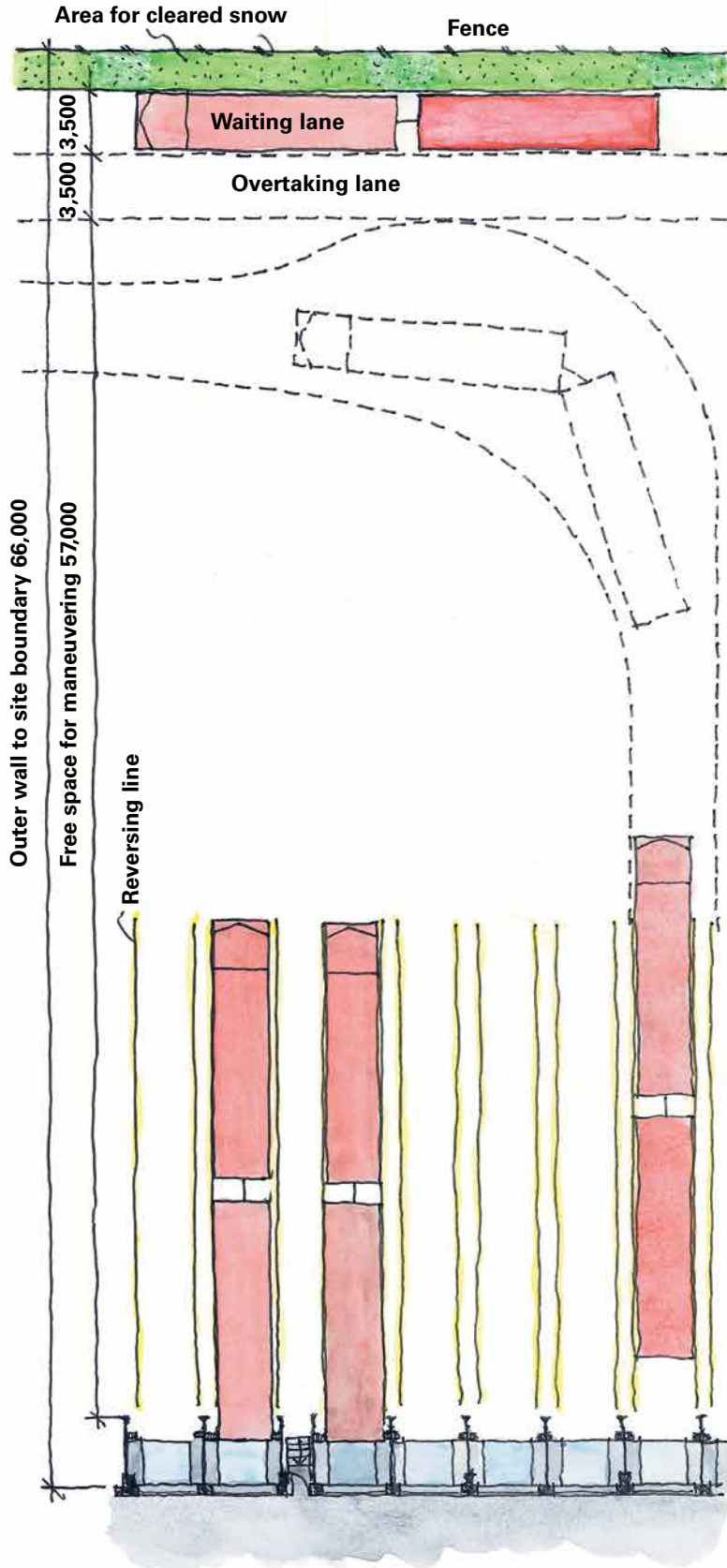

Vehicle route in dedicated driving area when driving backwards to the loading dock.

Degrees	Number of metres
30 degrees	19 m plus free lane and parking
45 degrees	30 m plus free lane and parking
60 degrees	38 m plus free lane and parking
90 degrees	50 m plus free lane and parking

## 17.4 Help reversing

### Illustration of reversing lines in dedicated driving space.

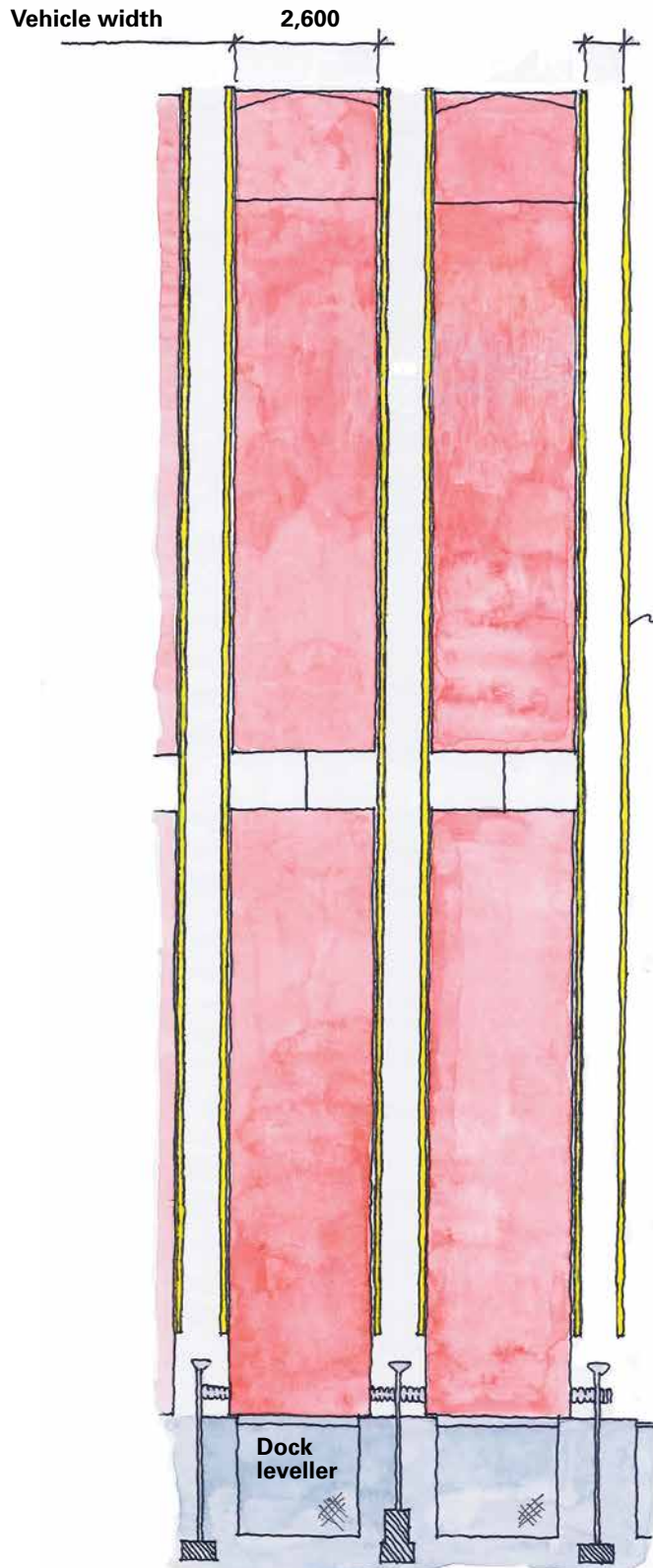

**1,500 mm of space is required between the vehicles so that the vehicle's rear doors can be opened just before docking to facilitate reversing.**

**Please note that reversing lines are painted using reflective yellow road paint so that they are easier to see in the winter.**

**Dock seals for 2,600 mm vehicles require a fitting space of 3,600 mm to close tightly around them.**

## 18. Fire safety and theft prevention

There are various safety risks associated with goods reception areas and these depend to a varying extent on the nature of the business that the goods reception serves.

Everyone – both property owners and tenants – should work systematically to prevent fires. The starting point for this should be the existing fire risks.

A systematic work method means ensuring knowledge of fire prevention is maintained and developed within the business. The scope of this systematic fire prevention work is governed by the nature of the business operating inside the building or facility and how this develops and changes.

Communication is most important between those who own, use or visit the building.

Fire risks can be handled in two different ways. The first is to prevent fires from breaking out, and the second is to minimise the damage caused by fire.

A fire needs air, combustible material and heat to start. It is important to identify potential ignition risks. Some examples of ignition risks that may arise in connection with goods reception activities are described below. The main principle is to prevent fire from spreading from and into buildings.

### 18.1 Loading docks with combustible material

The general rule is that combustible material should not be kept in a goods reception area because arson is often a spur of the moment crime. If combustible material is kept nearby, it is a basic requirement that there be access to a 6 kg powder extinguisher and indoor fire hydrant. It is also important that employees are trained to use this equipment.

Combustible material should be kept in a lockable, fireproof store or at least six metres away from the building. This also applies to refuse container areas. Other distances may apply depending on the goods reception's structural design.

Factors that may affect the spread of a fire in a building include canopies, which might catch fire and bring in flue gases, and leaky eaves that might release flue gases into the roof space.

If the external wall – including doors, gates and windows – satisfies class EI 30, i.e. resists fire for 30 minutes, combustible material can be stored directly adjacent to goods reception. Alternatively, if you need to store such material in the goods reception area, install an automatic fire alarm with smoke-detector controlled fire doors or roller shutters of class EI 30 that will close in the event of a fire, or install an automatic sprinkler system.

### 18.2 Pallet fires

Pallets burn with a very high energy output and fires spread very quickly in a warehouse where pallets are used. Experience shows that pallet fires generate large quantities of radiant heat, which means there is a risk of the fire spreading to nearby buildings and businesses. This is why large areas need to be set aside in order to maintain a safe distance. If pallets start to burn, it is very important to limit the fire quickly.

Pallets should be stored so that a fire, regardless of efforts made by the emergency services, does not spread to nearby buildings or materials. It is the distance between buildings that affects how many pallets can be stored. To make sure that heat radiation from a pallet fire does not ignite neighbouring buildings, the distance between the pallet store and buildings should vary depending on the method of storage.

To reduce the risk of arson, all storage of pallets should take place in an enclosed and monitored area. Storage should preferably take place in several smaller locations as opposed to a few larger locations. The stacking height increases both the maximum energy output in the event of a fire and the speed at which the fire grows, and should therefore be as low as possible.

Sections of wall that face pallet stores should be built to satisfy the necessary fire resistance class if it is thought that the radiation level will exceed 15 kW/m<sup>2</sup>. If there is a long heat radiation exposition, woods will light a fire at 13 kW/m<sup>2</sup>.

Emergency services should be able to easily gain access to put out any pallet fires. Contact the fire emergency services for help in planning a goods reception area that is as fireproof as possible.

When heat radiation of 15 kW/m<sup>2</sup>, the following distance applies to a storage height of 5.7 metres:

Storage area [m x m]	<b>20x20</b>	<b>25x25</b>	<b>40x40</b>	<b>50x50</b>
Distance [m]	<b>28</b>	<b>35</b>	<b>48</b>	<b>58</b>



## 18.4 Fire control systems

### 18.4.1 Passive fire control systems: handheld extinguishers and indoor fire hydrants

There should be handheld powder extinguishers just inside gates or similar openings at the goods reception. They should be displayed clearly so that they are easy to find. Other extinguishing substances may be used if the environment is extra sensitive to powder.

There should be an indoor fire hydrant adjacent to the loading dock.

Handheld fire extinguishers and indoor fire hydrants should not be blocked by obstacles. Equipment for fighting fires also needs to be available outside. This setup depends on local circumstances. One option is to have a 6 kg fire extinguisher next to every gate and a hand truck with various extinguisher types on it that can be rolled out quickly when needed.

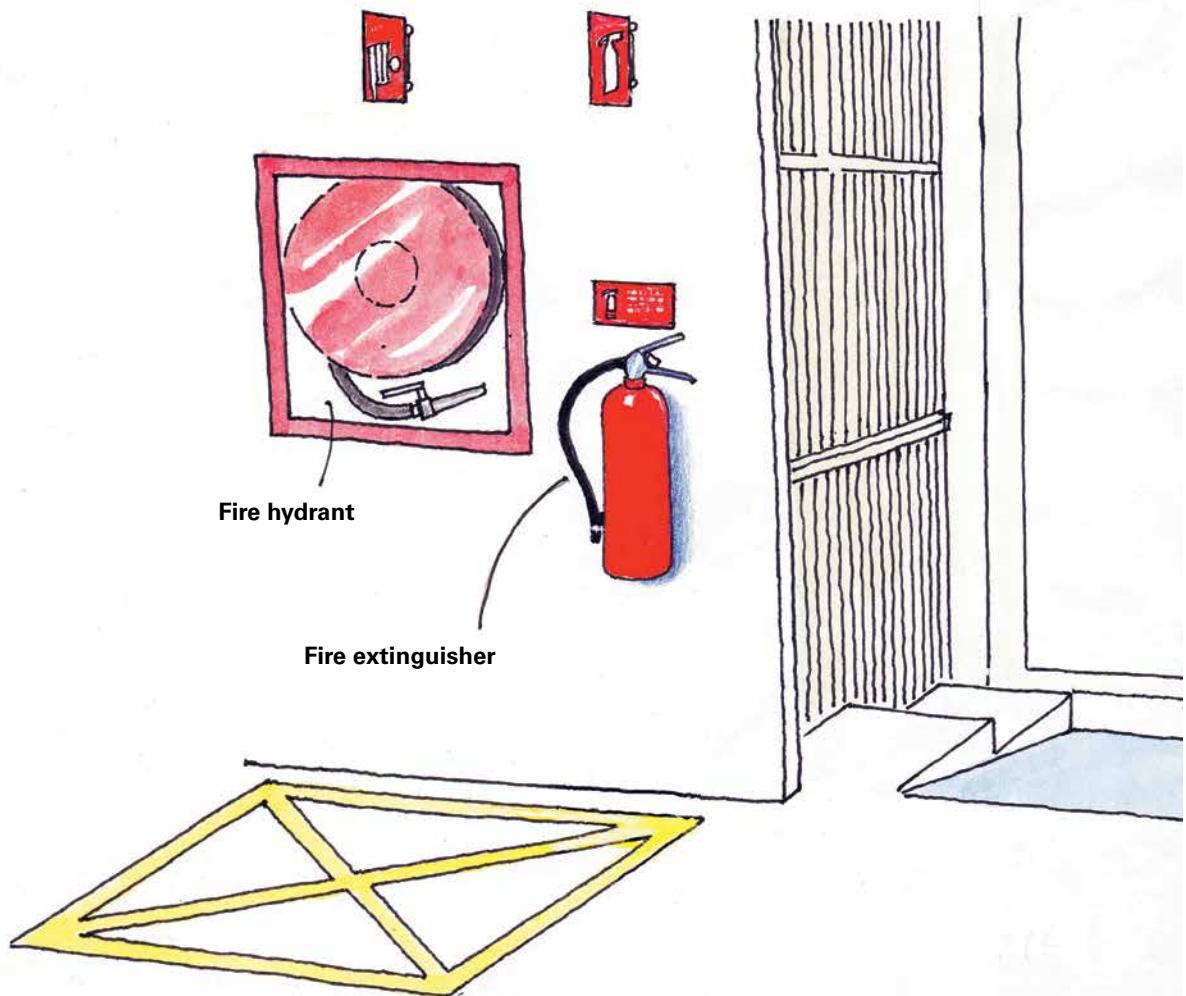

## 18.5 Evacuation

Emergency exits in goods reception areas and warehouses should be avoided since there is a significant risk of them being blocked by goods.

If the goods reception nevertheless houses an emergency exit, the points below should be included in the control system that forms part of the systematic fire prevention checks:

- Emergency exits should not be blocked.
- Emergency exits should have fluorescent or illuminated exit signs with an emergency power function.
- Emergency exits should have doors that open outwards in the direction of escape with steps to ground level off a landing just outside the door. Gates for vehicle traffic and doors with shutters are not acceptable as emergency exits.
- Emergency exits should be easy to open. They can be equipped with emergency exit pads or panic bars.
- Emergency exit doors should be alarmed during the day to reduce the risk of unauthorised access. If emergency exit doors are also used during ordinary operations, they should be equipped with card-readers so that authorised employees can use them without triggering the alarm.
- An emergency exit should be at least 90 cm wide.
- Emergency exits that lead out into the open should be equipped with a device preventing goods from blocking the emergency exit from the outside. This might be a prohibitory sign on the outside of the door stating "Emergency exit: do not block" and a fixed railing two metres in front of the door so that goods and vehicles cannot block the door.

## 18.6 Security

The safety of employees may depend on the functions built into a goods reception area. The person responsible for a property with a goods reception area should therefore carry out a risk assessment based on the relevant activities so that both accidents and crime can be prevented and danger minimised.

Burglars often try to break in through goods reception areas. With this in mind, it is better if several shops can set up a joint, staffed goods reception. At goods reception areas without staff, the drivers can be told via the entry phone where to leave the goods. A locked room with a one-off code is often used. Such a room may have CCTV cameras installed for extra security.

There should be information inside the goods reception gate clarifying the areas in which external and internal employees are allowed to enter.

Special attention should be paid to how gates and other access routes to and from goods reception areas are organised. A loading house with locked external gates is a good solution. The area outside goods reception should be enclosed with a fence and gates. Containers should not be accessible to unauthorised people. It should only be possible to use them from inside the warehouse.

Maintaining order on the loading dock and a good overview are crucial to reducing the risk of theft at goods reception areas. The lighting should be good and preferably controlled using a so-called twilight switch.

## 18.7 Gates with intruder protection

Up-and-over gates can be reinforced with steel sheeting on the inside of the gate leaf and equipped with an approved safety lock and intruder-proof window or peephole. Specific industry agreements govern this.

## 18.8 Secure site with CCTV

If people are inside the goods reception area for longer periods of time, restrooms may be required. CCTV is increasingly used to prevent theft. Experience shows that recorded material is of great help in understanding what happened, both in instances of crime and accidents at work. Note that permission is required for CCTV cameras. A decision to install a camera should be made in consultation between the parties, and the safety representative should participate in the decision.

The area outside the goods reception gates should be equipped with CCTV cameras so that before a gate is opened, it is easy for employees to see who is outside. The gates can also be equipped with intruder-proof windows or peepholes so that staff can see reversing vehicles and make sure that there are no unauthorised people outside.

Entry phones can be supplemented with CCTV cameras so that employees can see who is entering. Goods reception gates left open are a big problem. To avoid this, equipment is available that can close the gates automatically.

Gates at ground level can be equipped with automatic closing that stops if there are any obstacles in the gate opening. Notification of open or unlocked gates can be sent to central surveillance.

There should be personal attack buttons and CCTV cameras adjacent to goods reception gates. Portable alarms are recommended for employees.

Safety devices such as lighting, cameras and railings are also important measures for preventing crimes such as arson.

### A safe goods reception.

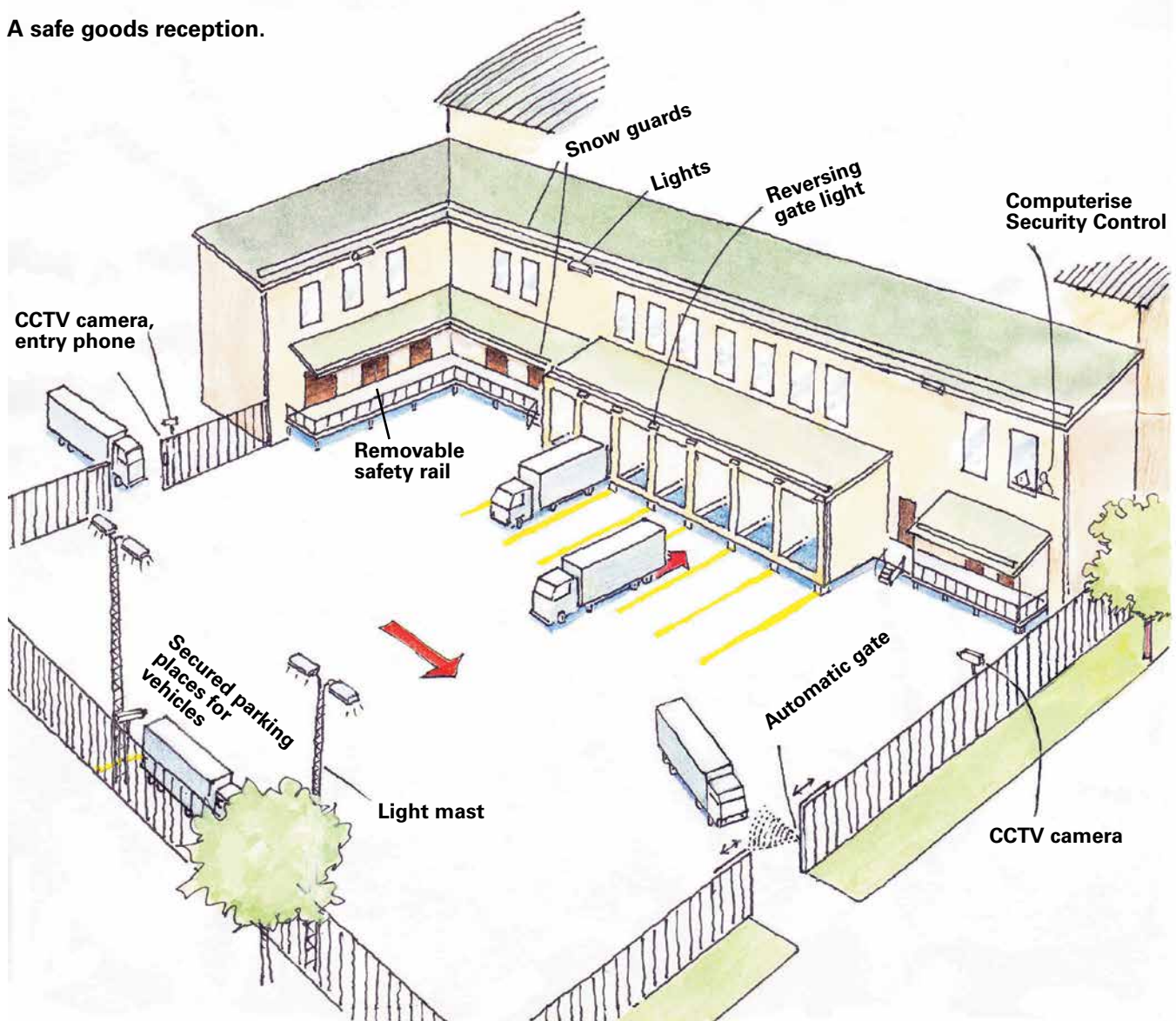

## 19. Lighting

Light plays a major role in reducing the risk of accidents both during manual goods handling and in connection with manoeuvring vehicles. Lighting is a factor that also contributes to reducing the risk of theft and the risk of unauthorised access.

300 lux lighting is normally used for transport routes. This intensity of illumination is insufficient in dark and dirty areas or even where the transport route is also used for storage on shelves or similar.

Goods reception staff are prone to adaptation difficulties, for example their eyes do not have time to adjust to the difference in brightness when moving between different areas or going from outside to inside.

It is particularly important that this is considered when loading and unloading involves driving forklift trucks into dark vehicles.

It is important that lighting is good when reversing. Light masts in the yard are insufficient, since there will be shadows behind the vehicle. Reverse lights should be dipped so that the driver is not dazzled when looking into their rear-view mirror. Dock levellers should not be used without a good overview. Lighting is required in the loading house, since otherwise it will be dark when a truck reverses up to it.

Lighting is often required inside the loading unit during loading and unloading. In cases such as these, the light should be directed at the ceiling to avoid dazzling employees.

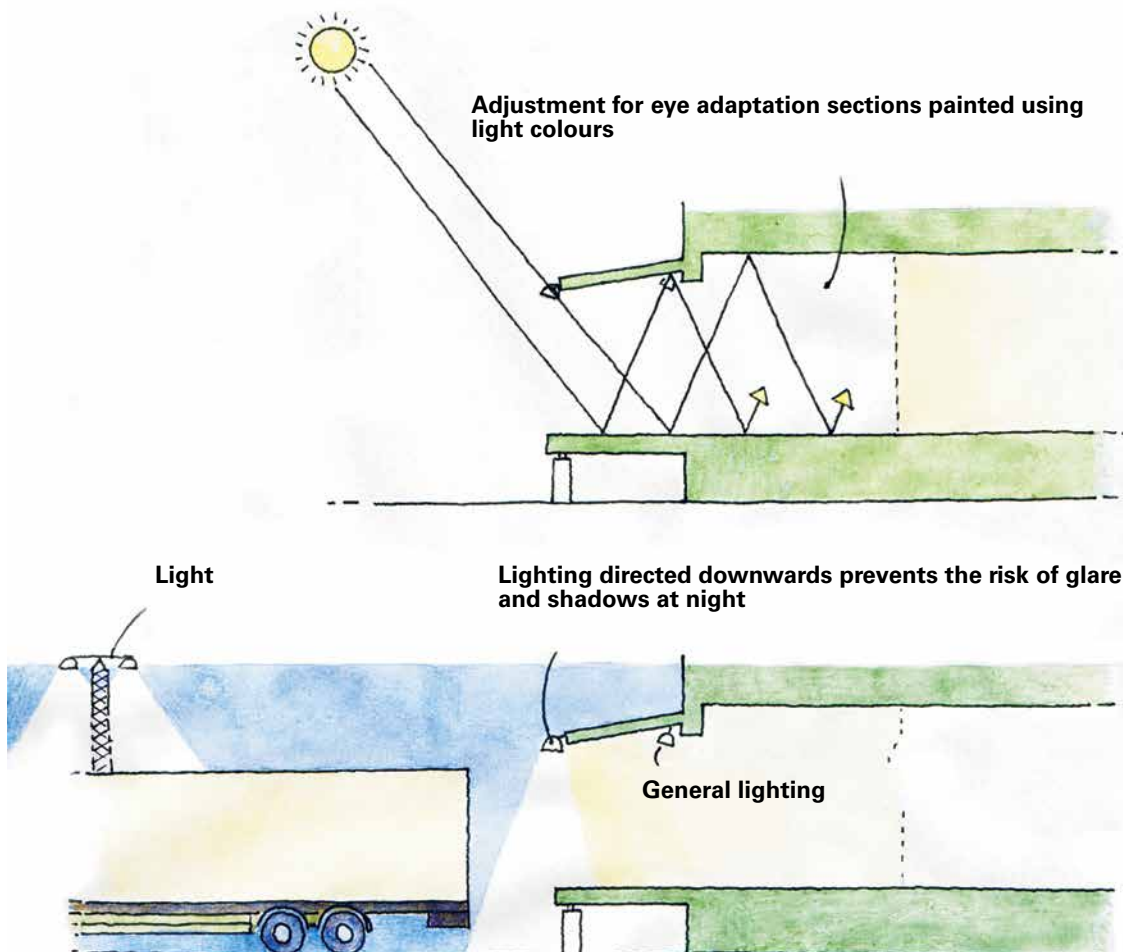

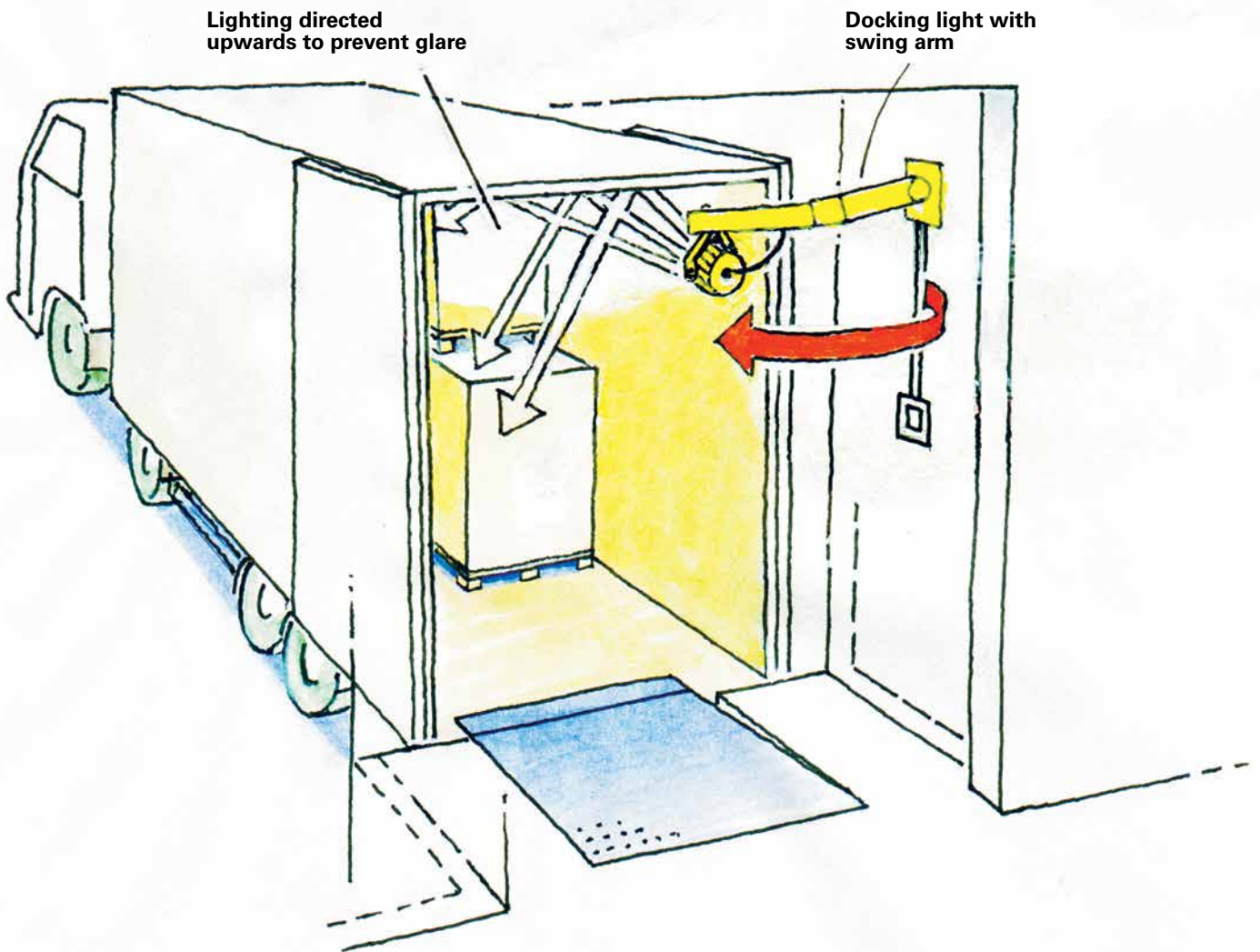

## 20. Waste sorting and return goods

Without safety being compromised an efficient goods reception should:

- have space for storing return goods, for containers and compactors for storing various fractions.
- permit traffic with various transport vehicles.

### 20.1 Waste sorting storage method

The need to transport waste sorted into various fractions to recycling plants is increasing in line with greater consideration being shown for the environment and

more companies achieving environmental certification. This might be environmentally hazardous waste, paper, wood, glass and metal or, in certain cases, infectious waste. Certain fractions might be combustible and constitute a fire hazard depending on the storage method.

The storage of sorted materials should take place in such a way that employees can leave materials in dedicated containers without needing to enter areas where vehicles are moving. It should be possible to store and dispose of various fractions without conflict arising with other businesses that use the goods reception.

**Containers of sorted material are emptied using container tippers.**



## 20.2 Return goods

Even if customers are offered the chance to recycle various types of return goods, it is important that the loading and unloading of return goods can take place

without goods traffic needing to operate in areas where customers and others might be.

See also Chapter 3, section 3 (Superstore) and 4 (Preschool, school).

### Return crates with conveyor belt from returnable glass.

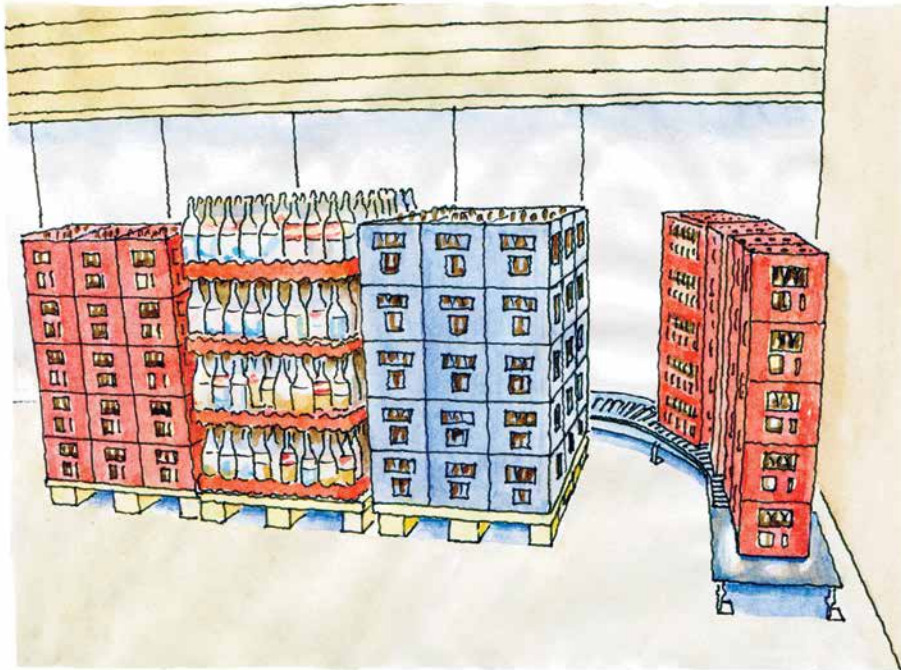

### Storage for wheeled cages, bread trays and pallets.

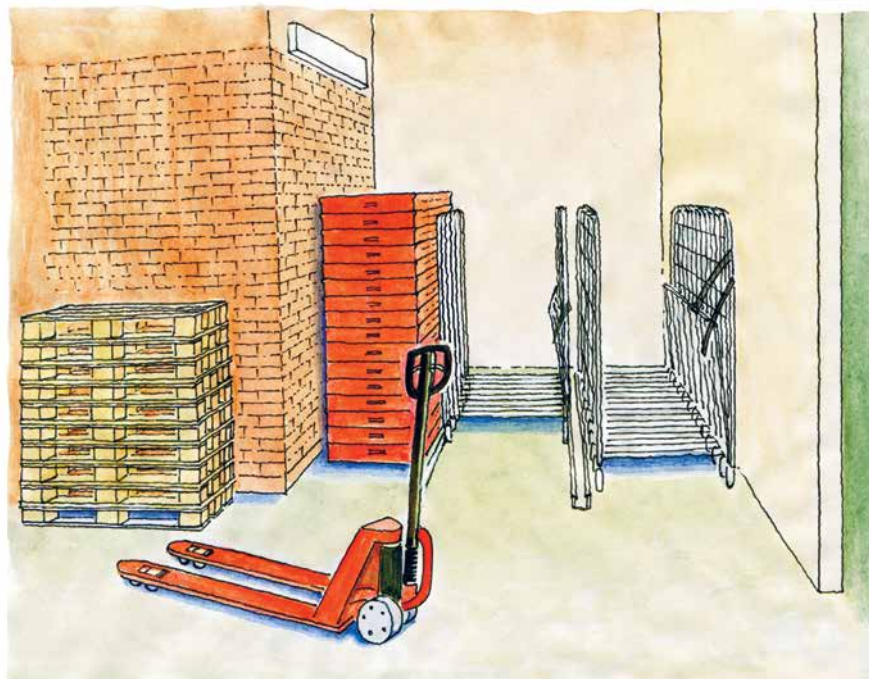

## References

- TYA - the Vocational Training and Working Environment Council (Transport Trades), Sweden; Bättre varumottag! Version 3, 2016.
- Health and Safety Authority Ireland (HSA) - information on managing vehicle risks at work :[www.vehiclesatwork.ie](http://www.vehiclesatwork.ie)



## IRU

La Voie-Creuse 16, CP 44  
CH-1211 Geneva 20, Switzerland  
+41-22-918 27 00 (tel)  
+41-22-918 27 41 (fax)  
iru@iru.org

iru.org

Learn more here about IRU and its activities  
in the world

[iru.org](http://iru.org)       